

# SAM4S

---

ER-420M

# Operation and Program Manual





All specifications are subject to change without notice

# Precaution Statements

Follow these safety, servicing and ESD precautions to prevent damage and to protect against potential hazards such as electrical shock.

## 1-1 Safety Precautions

1. Be sure that all built-in protective devices are replaced. Restore any missing protective shields.
2. When reinstalling the chassis and its assemblies, be sure to restore all protective devices, including nonmetallic control knobs and compartment covers.
3. Make sure there are no cabinet openings through which people - particularly children - might insert fingers and contact dangerous voltages. Such openings include excessively wide cabinet ventilation slots and improperly fitted covers and drawers.
4. Design Alteration Warning:  
Never alter or add to the mechanical or electrical design of the SECR. Unauthorized alterations might create a safety hazard. Also, any design changes or additions will void the manufacturer's warranty.
5. Components, parts and wiring that appear to have overheated or that are otherwise damaged should be replaced with parts that meet the original specifications. Always determine the cause of damage or over- heating, and correct any potential hazards.
6. Observe the original lead dress, especially near the following areas: sharp edges, and especially the AC and high voltage supplies. Always inspect for pinched, out-of-place, or frayed wiring. Do not change the spacing between components and the printed circuit board. Check the AC power cord for damage. Make sure that leads and components do not touch thermally hot parts.
7. Product Safety Notice:  
Some electrical and mechanical parts have special safety-related characteristics that might not be obvious from visual inspection. These safety features and the protection they give might be lost if the replacement component differs from the original - even if the replacement is rated for higher voltage, wattage, etc.  
Components that are critical for safety are indicated in the circuit diagram by shading, () or (). Use replacement components that have the same ratings, especially for flame resistance and dielectric strength specifications. A replacement part that does not have the same safety characteristics as the original might create shock, fire or other hazards.

### CAUTION

There is the danger of explosion if battery is incorrectly replaced.

Replace only with the same or equivalent type recommended by the manufacturer.

Dispose used batteries according to the manufacturer's instructions.

### ATTENTION

Il y a danger d'explosion s'il y a remplacement incorrect de la batterie.

Remplacer uniquement avec une batterie du même type ou d'un type équivalent recommandé par le constructeur.

Mettre au rebut les batteries usagées conformément aux instructions du fabricant.

**SAFETY NOTICE:** "For pluggable equipment, the socket-outlet shall be installed near the equipment and shall be easily accessible."

## 1-2 Servicing Precautions

**WARNING:** First read the-Safety Precautions-section of this manual. If some unforeseen circumstance creates a conflict between the servicing and safety precautions, always follow the safety precautions.

**WARNING:** An electrolytic capacitor installed with the wrong polarity might explode.

1. Servicing precautions are printed on the cabinet. Follow them.
2. Always unplug the units AC power cord from the AC power source before attempting to:
  - (a) Remove or reinstall any component or assembly
  - (b) Disconnect an electrical plug or connector
  - (c) Connect a test component in parallel with an electrolytic capacitor
3. Some components are raised above the printed circuit board for safety. An insulation tube or tape is sometimes used. The internal wiring is sometimes clamped to prevent contact with thermally hot components. Reinstall all such elements to their original position.
4. After servicing, always check that the screws, components and wiring have been correctly reinstalled. Make sure that the portion around the serviced part has not been damaged.
5. Check the insulation between the blades of the AC plug and accessible conductive parts (examples: metal panels and input terminals).
6. Insulation Checking Procedure: Disconnect the power cord from the AC source and turn the power switch ON. Connect an insulation resistance meter (500V) to the blades of AC plug.

The insulation resistance between each blade of the AC plug and accessible conductive parts (see above) should be greater than 1 megohm.
7. Never defeat any of the B+ voltage interlocks. Do not apply AC power to the unit (or any of its assemblies) unless all solid-state heat sinks are correctly installed.
8. Always connect an instrument's ground lead to the instrument chassis ground before connecting the positive lead; always remove the instrument's ground lead last.

## 1-3 Precautions for Electrostatic Sensitive Devices (ESDs)

1. Some semiconductor (solid state) devices are easily damaged by static electricity. Such components are called Electrostatic Sensitive Devices (ESDs); examples include integrated circuits and some field-effect transistors. The following techniques will reduce the occurrence of component damage caused by static electricity.
2. Immediately before handling any semiconductor components or assemblies, drain the electrostatic charge from your body by touching a known earth ground. Alternatively, wear a discharging wrist-strap device. (Be sure to remove it prior to applying power - this is an electric shock precaution.)
3. After removing an ESD-equipped assembly, place it on a conductive surface such as aluminum foil to prevent accumulation of electrostatic charge.
4. Do not use Freon-propelled chemicals. These can generate electrical charges that damage ESDs.
5. Use only a grounded-tip soldering iron when soldering or unsoldering ESDs.
6. Use only an anti-static solder removal device. Many solder removal devices are not rated as anti-static; these can accumulate sufficient electrical charge to damage ESDs.
7. Do not remove a replacement ESD from its protective package until you are ready to install it. Most replacement ESDs are packaged with leads that are electrically shorted together by conductive foam, aluminum foil or other conductive materials.
8. Immediately before removing the protective material from the leads of a replacement ESD, touch the protective material to the chassis or circuit assembly into which the device will be installed.
9. Minimize body motions when handling unpackaged replacement ESDs. Motions such as brushing clothes together, or lifting a foot from a carpeted floor can generate enough static electricity to damage an ESD.



# Contents

<b>Getting Started</b>	<b>1</b>
About the <i>ER-420M</i> .....	1
Unpacking.....	1
Installing the Paper .....	1
Basic Features and Functions .....	1
Standard Hardware.....	1
Optional Hardware .....	1
Software Features.....	1
Front Display.....	1
Rear Display .....	1
Control Lock .....	1
Keyboards.....	1
Memory Clear.....	1
Memory All Clear .....	1
Initial Clear .....	1
<b>Operating Instructions</b>	<b>1</b>
Function Key Descriptions .....	1
Clerk Sign-On/Sign-Off .....	1
Direct Sign-On .....	1
Coded Sign-On.....	1
Receipt On and Off.....	1
Item Registrations.....	1
Open Keyboard PLU Entry .....	1
Preset Price Keyboard PLU.....	1
Keyboard PLU Repeat Entry.....	1
Keyboard PLU Multiplication.....	1
Keyboard PLU Multiplication with Decimal Point.....	1
Split Pricing (Keyboard PLU).....	1
Single Item Keyboard PLU .....	1
Open Code Entry PLU .....	1
Preset Price Code Entry PLU .....	1
Code Entry PLU Multiplication .....	1
Code Entry PLU Multiplication with Decimal Point .....	1
Split Pricing Code Entry PLU .....	1
Modifier Key .....	1
Price Level Key .....	1
PROMO.....	1
Waste.....	1
KBD SHIFT .....	1
Percent Key Operations .....	1
Preset Percent Discount on an Item.....	1
Enter a Percent Discount on an Item .....	1
Percent on Sale Total.....	1
Coupon on Sale (Vendor Coupon).....	1
Coupon on Item (Store Coupon) .....	1
Return Merchandise Registrations.....	1
Voids and Corrections .....	1

Error Correction (Void Last Item).....	1
Void Previous Item.....	1
Cancel.....	1
Void Position Operations .....	1
No Sale Operations .....	1
Open Drawer .....	1
Non Add Number .....	1
Received On Account Operations.....	1
Paid Out Operations.....	1
Subtotalling a Sale .....	1
Totalling and Tendering.....	1
Totalling a Cash Sale.....	1
Totalling a CHECK Sale .....	1
Tendering a Cash Sale.....	1
Tendering a CHECK Sale.....	1
Totalling a Charge Sale .....	1
Tendering a Charge Sale.....	1
CHECK Cashing .....	1
Split Tender .....	1
Post Tender.....	1
Currency Conversion.....	1
Table Management and Clerk Interrupt Operations .....	1
Overview .....	1
Soft Check .....	1
Hard Check.....	1
<b>X/Z Mode</b> .....	<b>1</b>
Introduction.....	1
X Reports .....	1
Running a Report – General Instructions .....	1
Report Table .....	1
Reset Hard Check Line # .....	1
Cash Declaration.....	1
<b>Service Mode Programming</b> .....	<b>1</b>
Overview.....	1
Memory Allocation Scan .....	1
PC Online Mode .....	1
Memory Allocation.....	1
Clear Totals.....	1
Clear Grand Totals.....	1
Clear PLU File.....	1
Eprom Information .....	1
Function Key Assignment Programming.....	1
Function Key Codes .....	1
RS232C Port 1/RS232C Port 2 Options .....	1
<b>Program Mode Programming</b> .....	<b>1</b>
Default Programming.....	1
Descriptor Programming Methods.....	1
Program Overlay Method .....	1
Descriptor Code.....	1
Tax Programming .....	1
Straight Percentage Tax Rate Programming.....	1
PLU Programming .....	1
Program 100 - PLU Status Programming .....	1
Program 110 - PLU Auto Tare Programming .....	1

Program 150 - PLU Group Assignment .....	1
Program 200 - PLU Price/HALO Programming .....	1
Program 250 - PLU Stock Amount Programming .....	1
Program 300 - PLU Description Programming .....	1
Program 350 - PLU Link Programming .....	1
Program 400 - PLU Delete Programming .....	1
Program 450 - PLU MIX & MATCH Programming .....	1
System Option Programming .....	1
System Option Table .....	1
Print Option Programming .....	1
Print Option Table .....	1
Function Key Programming .....	1
Program 70 - Function Key Options .....	1
Program 80 - Function Key Descriptor .....	1
Program 90 - Function Key HALO .....	1
ADD CHECK .....	1
CANCEL .....	1
CASH .....	1
CHARGE1-8 .....	1
CHECK .....	1
CHECK CASHING .....	1
CHECK ENDORSEMENT .....	1
CHECK # .....	1
CURRENCY CONVERSION .....	1
DRIVE THRU / EAT IN / TAKE OUT .....	1
ERROR CORRECT .....	1
F/S TEND .....	1
GUEST .....	1
Price LEVEL1-2 .....	1
#/NS .....	1
RETURN .....	1
MODIFIER 1-5 .....	1
PAYMENT .....	1
PBAL .....	1
PROMO .....	1
PAID OUT1-3 .....	1
PRINT CHECK .....	1
RECD ON ACCT1-3 .....	1
SCALE .....	1
SERVICE .....	1
SUBTOTAL .....	1
TARE .....	1
TAX EXEMPT .....	1
TIP .....	1
VALIDATE .....	1
VOID .....	1
WASTE .....	1
% 1- %5 .....	1
KBD SHIFT .....	1
Clerk Programming .....	1
Program 800 - CLERK Secret Code Programming .....	1
Program 801 - Clerk Status Programming .....	1
Program 810 - Clerk Description Programming .....	1
Mix & Match Programming .....	1
Program 600 - Trip Level Programming .....	1
Program 601 - Price Programming .....	1
Program 610 - Mix & Match Description Programming .....	1
Group Programming .....	1
Miscellaneous Programming .....	1

Macro Key Sequence Programming .....	1
Logo Description Programming .....	1
NLU Code Number Programming.....	1
Cash-In-Drawer Limit Programming .....	1
CHECK Change Limit Programming.....	1
Date and Time Programming.....	1
Machine Number Programming .....	1
Program Scans .....	1

**Sample Reports** **1**

Financial .....	1
Time .....	1
PLU .....	1
Clerk .....	1
Individual Clerk .....	1
Groups.....	1
Stock .....	1
Open Check .....	1



# Getting Started

---

## About the *ER-420M*

- The *ER-420M* features a 48-position keyboard with traditional raised keys. This keyboard will accommodate up to 12 NLU keys and works best in retail stores, or shops where it is not necessary to place a large number of preset item keys on the keyboard.

*ER-420M* is an excellent low cost solution for a wide range of retail environments.

*ER-420M*, with its superb thermal printing system, always provides the fastest in transaction speeds.

---

## Unpacking

1. Unpack and unwrap the cash register.
2. Located in the packing are the following items:
  - 1 Rolls of paper and paper spindle,
  - 2 sets of control keys,
  - Operation and Program Manual,
3. Remove the cardboard protectors from the cash drawer.
4. Plug the register into a grounded outlet (three prong), insert a control key and turn the key to the **REG** control lock position.

---

## Installing the Paper

1. Remove the printer cover.

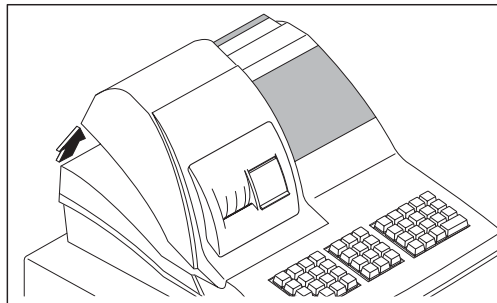

2. For proper feeding through the print head, cut or tear a straight even edge on the end of the paper roll. (Be sure to remove any paper with glue residue.) Place the paper roll in the paper holder so that the paper will feed from the bottom of the roll.

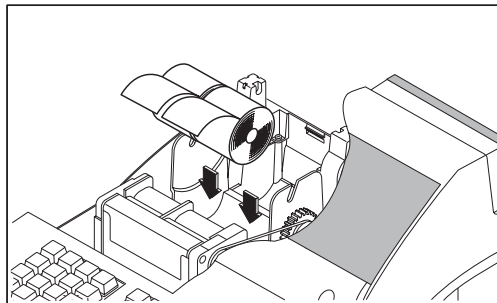

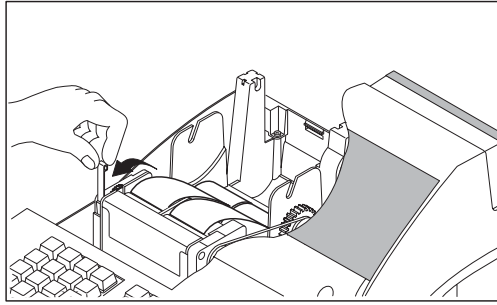

3. Insert the end of the paper into the paper slot.

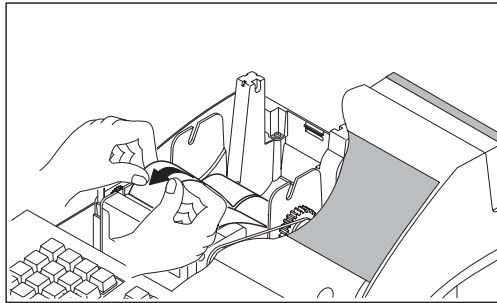

4. Close the paper lever and press the PAPER FEED key until the paper comes out.

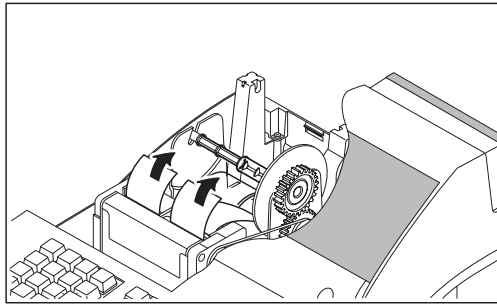

5. Passing the leading edge of the paper through the cutter slot. Tear off the excess paper. Replace the printer cover.

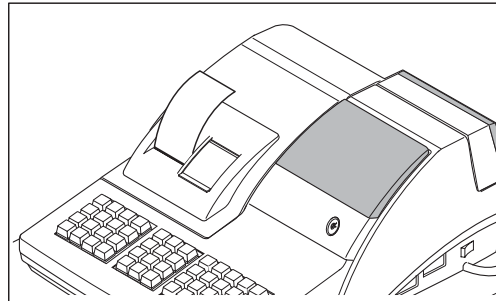
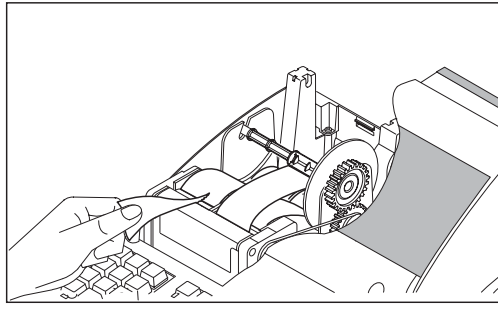

- ※ If you wish to use the printer to print a sales journal, insert the paper into the paper take-up spool. Wind the paper two or three turns around the spool shaft and install the spool in the mount.

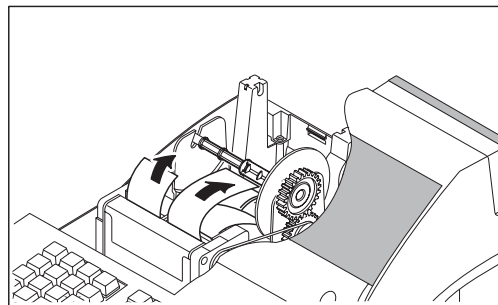

- ※ *ER-420M* is possible to feed automatically when you rock the paper levers and insert paper.

---

## Basic Features and Functions

### Standard Hardware

- 2 Line, 16 character liquid crystal display (LCD).
- Ten-position rear pop up display standard.
- 48 position raised keyboard.
- 2 station Thermal printer with drop-and-print mechanism.
- Sturdy Metal Cash Drawer with removable 4 Bill 8 Coin drawer insert.
- 7-position control lock.
- Standard customer pole display.
- Communications ports: 2 RS232C.

### Optional Hardware

- Kitchen printer. / Bill Printer / Journal Printer
- Bar code scanner.
- PC Link

### Software Features

- Up to 2 price levels for each PLU.
- Up to 5 PLU modifier keys.
- 9,000 (expandable) Price Look Ups (PLUs) for open or preset item registration. For direct registrations, up to 12 PLUs are on the keyboard.
- 18 character programmable descriptors for PLUs and functions.
- Up to 99 PLU Group totals.
- Up to 99 clerks with separate report totals.

## Front Display

The *ER-420M* comes with a liquid crystal screen, allowing you to view up to 2 lines of information with up to 20 characters per line. The display is backlit and adjustable to provide excellent visibility, regardless of lighting conditions.

When the control lock is in the OFF position, the register cannot be operated. When the control lock in the REG, VOID, X, Z, PGM or SM positions the appropriate message, there are displayed with the message "CLOSED". You must sign on a clerk to remove the "CLOSED" message and begin operation.

### REG

<b>REG MODE</b> <b>CLOSED</b>
----------------------------------

### VOID

<b>VOID MODE</b> <b>CLOSED</b>
-----------------------------------

### Operator Display Example

- ◆ Press 10.00 – PLU117 to register of the PLU117

<b>PLU117</b>	
<b>1</b>	<b>10.00</b>

- ◆ Press 50.00 – CASH to tender a sale

<b>CASH</b>	<b>50.00</b>
<b>CHANGE</b>	<b>40.00</b>

### Displayed Error Conditions

<b>** WARNING **</b> <b>SEQUENCE ERR</b>
---

## Rear Display

The rear display is a 10 digit florescent display that allows your customer to monitor the transaction and view the sale total. The rear display can be lifted and turned for easy customer viewing.

### *Rear Display Information*

<b>Item Count</b>	The number of times an item has been repeated is displayed
<b>Amount</b>	The amount of the item, subtotal or total, is displayed in the rightmost portion of the display

### *Rear Display Message*

<b>C</b>	Change Due
<b>-</b>	Negative entry
<b>Sub</b>	Subtotal of the sale
<b>=</b>	Total of the sale

## **Error Code Table**

<b>E0</b>	SEQUENCE ERROR
<b>E1</b>	PLU NO DATA
<b>E2</b>	CLERK ERROR
<b>E3</b>	AMOUNT COUNT OVER
<b>E4</b>	LAN TRAN
<b>E5</b>	COMMUNICATION ERROR
<b>E6</b>	TIME AND DATE
<b>E7</b>	LIMIT OVER
<b>E8</b>	INACTIVE
<b>E9</b>	XMODE ONLY
<b>E10</b>	NONADD
<b>E11</b>	ADDCHECK ERROR
<b>E12</b>	CONDIMENT ERROR
<b>E13</b>	REQ. EAT IN
<b>E14</b>	REQ. STOCK
<b>E15</b>	REQ.DRAWER
<b>E16</b>	REQ.GUEST
<b>E17</b>	SCALE
<b>E18</b>	CLERK NOT MATCH
<b>E19</b>	COMPULSORY TARE
<b>E20</b>	REQ.DECLARATION
<b>E21</b>	OFF LINE
<b>E22</b>	REQ.ENDORSEMENT
<b>E23</b>	CONSOL OVER
<b>E24</b>	REQ.SUBTOTAL
<b>E25</b>	PROMO ERROR
<b>E26</b>	CHECK OPEN
<b>E27</b>	REQ. PASSWORD
<b>E28</b>	NO VOID PLU
<b>E29</b>	232C SETUP ERROR
<b>E30</b>	REQ.PRESET VALUE
<b>E31</b>	REQ. OPEN VALUE
<b>E32</b>	REQ. AMOUNT
<b>E33</b>	REQ. PAYMENT



<b>E34</b>	INVALID FUNCTION
<b>E35</b>	REQ. TABLE
<b>E36</b>	REQ. PBAL
<b>E37</b>	REQ.CHECK #
<b>E38</b>	ONLY ONE TABLE
<b>E39</b>	REQ. VALID
<b>PER</b>	RECEIPT PRINTER PAPER END
<b>PFP</b>	SYSTEM ERROR (If this problem occurs, call the service engineer.)
<b>E42</b>	MEMORY ALLOCATION ERROR
<b>E43</b>	PLU DELETE ERROR
<b>PEJ</b>	JOURNAL PRINTER PAPER END
<b>E45</b>	RECEIPT AND JOURNAL PRINTER END

## Control Lock

The control lock has 7 positions, accessed with 5 keys. Each ECR is shipped with two full sets of keys.

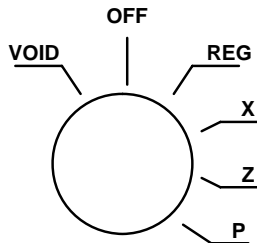

- VOID** Use to void (correct) items outside of a sale.
- OFF** The register is inoperable.
- REG** Use for normal registrations.
- X** Use to read register reports.
- Z** Use to read register reports and reset totals to zero.
- P** Use to program the register.
- S** The S position is a hidden position reserved for dealer access.

Before performing any operations in Register Mode a clerk must be signed on. See “Clerk Sign-On/Sign-Off” for a description of clerk operations.

## Control Keys

The *ER-420M* includes two sets of keys that may be used to access the following control lock positions.

Key	Positions Accessible
<b>REG</b>	OFF, REG
<b>VOID</b>	VOID, OFF, REG, X
<b>Z</b>	VOID, OFF, REG, X, Z
<b>P</b>	VOID, OFF, REG, X, Z, P
<b>C</b>	ALL POSITIONS

---

Note: Keys may be removed from the control lock in the OFF or REG positions.

---

# Keyboards

The *ER-420M* keyboard is shown below with the default legends and key assignments. This configuration has 12 keyboard NLU locations. Programmable key locations are shown with a bold border.

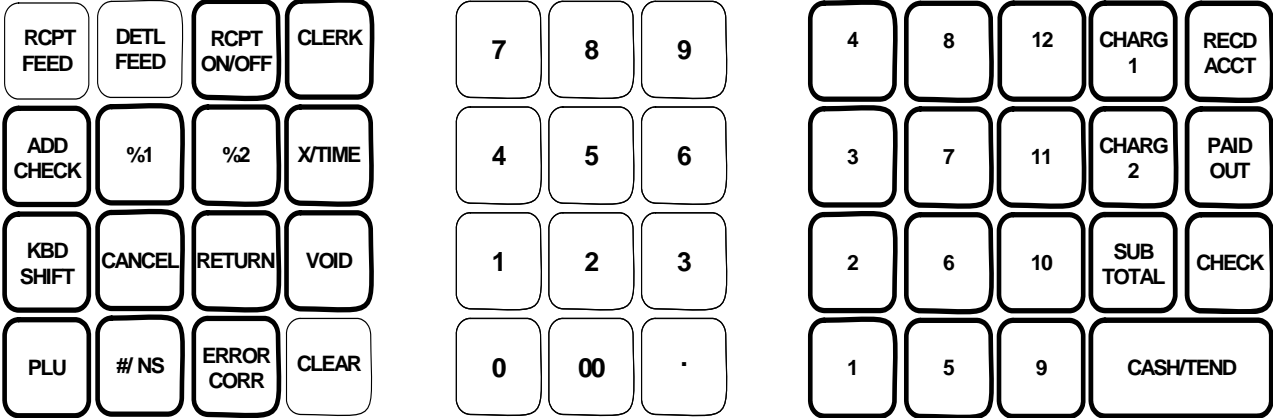

---

## Memory Clear

---

**CAUTION:** The procedures described in this area are security sensitive. Clearing all or parts of the ER-420M memory may cause damage or loss to the program. Do not share this information with unauthorized users and distribute the special SERVICE-Mode key only to those you may want to perform these functions.

---

### Memory All Clear

Perform "Clear All Totals", or "Clear PLU File" if you wish to clear only parts of *ER-420M* memory. Complete clearing of all memory areas and installation of the default program can be done through the following special procedure:

1. Turn the power switch located on the right side of the register to the OFF position.
2. Turn the control lock to the S position one position.
3. Press and hold the key position where the **CHECK** key is located on the default keyboard layout.
4. Continue to hold the **CHECK** key while turning the power switch to the ON position.
5. Press the upper left key of the keyboard, then the lower left key, then the upper right key, and finally press the lower right key.
6. When memory is cleared, the register prints a message "RAM ALL CLEAR OK!"

---

## Initial Clear

---

**CAUTION:** Do not share this information with unauthorized users. Distribute the P Mode key only to those you may want to perform this function.

---

The initial clear function allows you to exit any register activity and return to a beginning or cleared state. Any transaction that is in progress will be exited and totals for that transaction will not be updated.

Here are some reasons you may want to perform an initial clear:

- The register is in an unknown state, and you wish to exit the current program or transaction without following normal procedures.
- You have performed a function that includes a compulsory activity and you wish to bypass the compulsion.
- An initial clear may be necessary as part of servicing, or troubleshooting.

### ***To Perform an Initial Clear:***

1. Unplug the register.
2. Turn the control lock to the **P** position.
3. Press and hold the key position where the **SBTL** key is located on the default keyboard layout.
4. While continuing to hold the **SBTL** key, plug the register into a power source.
5. The message "INITIAL CLEAR OK!" prints when the initial clear is complete.



# Operating Instructions

---

## Function Key Descriptions

Keys are listed in alphabetical order. Some of the keys described below are not included on the default keyboard. See “Function Key Assignment Programming to add or change programmable keys.

Keyboard Legend	Description
<b>#/NO SALE</b>	Use as a non-add key to print up to an 8-digit numeric entry on the receipt and journal. This entry will not add to any sales totals. The <b>#/NO SALE</b> key is also used to open the cash drawer without making a sale.
<b>X/TIME</b>	Use to multiply a quantity of items or calculate split pricing on PLU entries.
<b>00, 0-9, Decimal</b>	Use to make numeric entries in <b>REG, X, Z, VOID, or P</b> positions. The decimal key is used for decimal or scale multiplication, when setting or entering fractional percentage discounts, or when programming fractional tax rates. Do not use the decimal key when making amount entries into PLUs.
<b>ADD CHECK</b>	Use to combine individual trays (in a cafeteria situation) that will be paid together. Each tray subtotal can advance the consecutive number, depending on programming.
<b>CANCEL</b>	Cancels a transaction without updating PLU, or function key totals. The Cancel function may only be used prior to tendering. Once tendering begins, the Cancel function may no longer be used. The <b>CANCEL</b> key corrects the appropriate totals and counters and the Financial report records total of transactions cancelled.
<b>CASH</b>	Calculates the sale total including tax, finalises the sale, and opens the cash drawer. Change computation is allowed by entering an amount before pressing the <b>CASH</b> key. The cash drawer will open only if the amount tendered is equal to or greater than the total amount of the sale. Post tendering is also available should a second change calculation be necessary. Re-enter the tendered amount and press the <b>CASH</b> key to show the new change computation. Press the <b>CASH</b> key a second time to issue a buffered receipt (up to 200 lines) when the receipt on/off function is OFF.

<b>CHECK</b>	Use to finalise CHECK sales. Calculates the sale total including tax, finalises the sale, and opens the cash drawer. Change computation is allowed by entering an amount before pressing the CHECK key. The cash drawer will open only if the amount tendered is equal to or greater than the total amount of the sale. Change issued will be subtracted from the appropriate in-drawer total.
<b>CHECK CASHING</b>	Use to exchange a CHECK for cash. Cash-in-drawer and CHECK-in-drawer totals are adjusted.
<b>CHECK ENDORSEMENT</b>	Use to print a CHECK endorsement message on an optional slip printer with a programmable endorsement message.
<b>CHARGE(1-8)</b>	Use to finalise charge sales. Calculates the sale total including tax, finalises the sale, and opens the cash drawer. Change computation is allowed by entering an amount before pressing the <b>CHARGE</b> key. The cash drawer will open only if the amount tendered is equal to or greater than the total amount of the sale. Change issued will be subtracted from the appropriate in-drawer total.
<b>CHECK #</b>	The <b>CHECK #</b> key is used to begin a new, or access an existing balance (hard check) or itemized bill (soft check.)  Check track numbers that are entered manually may be set at a fixed length of one to nine digits. Check track numbers assigned automatically will begin with #1.  Existing checks are accessed by entering the check track number and pressing the <b>CHECK #</b> key.
<b>CLEAR</b>	Use to clear entries made into the 10 key numeric pad or <b>X/TIME</b> key before they are printed. Also used to clear error conditions.
<b>CLERK</b>	The register will not operate in register mode unless a clerk has been signed on. Clerk sign-on is accomplished by direct or secret code sign on.  All entries made on the register will report to one of the 15 clerk totals. When a clerk is signed on, all entries following will add to that clerk's total until another clerk is signed on. However, a clerk cannot be changed in the middle of a transaction.  To sign a clerk off, thereby displaying the "CLOSED" message on the display, enter 0 (zero), then press the <b>CLERK</b> key. This disables the register until another clerk is signed on. The current clerk must first be signed off before another clerk can sign on.
<b>CONV (1 &amp; 4)</b>	The currency conversion function, allowed after subtotal, converts and displays the new subtotal at a preprogrammed exchange rate. Tendering is allowed after using the currency conversion function. Change is calculated and issued in home currency. The amount of foreign currency tendered is stored in a separate total on the Financial report, but not added to the drawer total.
<b>EAT-IN, TAKE-OUT, DRIVE-THRU</b>	Sale analyse 1,2,3 keys (Eat-in, Take-out and Drive-thru), are subtotal functions. In areas that have different tax rules for eat-in and take out sales, each key can be programmed to automatically charge or exempt taxes. Sales may not be split between each key.
<b>ERROR CORR</b>	Use to correct the last entry. The <b>ERROR CORR</b> key corrects the appropriate totals and counters.



<b>KBD SHIFT</b>	This function provides three levels of keyboard.
<b>F/S SHIFT</b>	When pressed before a PLU entry, the <b>F/S SHIFT</b> key reverses the preprogrammed food stamp status of the PLU. For example, an item not food stamp eligible can be made food stamp eligible.
<b>F/S SUB</b>	Displays the amount of the sale that is food stamp eligible.
<b>F/S TEND</b>	Use to tender food stamps for eligible sales.
<b>GUEST #</b>	Use to enter the count of guests served as part of a guest check.
<b>MACRO (1-10)</b>	Macro keys may be programmed to record, then later perform, up to 50 keystrokes. For example, a macro key could be set to tender (preset tender) a common currency, such as \$ 5 into the cash key.
<b>RETURN ITEM</b>	Used to return or refund merchandise. Returning an item will also return any tax, which may have been applied.
<b>MODIFIER 1-5</b>	The Modifier key alters the next PLU registered, either by changing the Code number of the PLU so that a different item is registered, or by adding the modifier descriptor.
<b>P/BAL</b>	Use to enter the amount of an outstanding balance.
<b>PAID OUT</b>	Use to record money taken from the register to pay invoices, etc. The paid out amount subtracts from the cash-in-drawer total. Paid outs are allowed outside of a sale only.
<b>% Keys 1-5</b>	Up to five % keys may be placed on the keyboard. Each % key is set with a specific function, such as item discount or surcharge, or sale discount or surcharge. The percent rate may be entered or preprogrammed, or the percent keys can be programmed with a negative, open or preset price, thus acting as coupon keys.  A percentage key may also be set up to accept charge tip entries.
<b>PLU</b>	The PLU key is used to register price look ups by number entry. PLUs can be programmed open or preset, and positive or negative.
<b>PAYMENT</b>	Use to Charge Posting Feature. This key can be enforced prior to cashing off a check sale.
<b>PRINT CHECK</b>	Use to print a guest check. The check can be printed on an optional (RS-232C) printer, or can be printed on the receipt printer. The <b>PRINT CHECK</b> key can be set to automatically service the check.
<b>PROMO</b>	The <b>PROMO</b> key allows you to account for PROMOAal items. Pressing this key will remove an item's cost from the sale, but will include the sale of the item in the item's sales counter.
<b>RECD ACCT</b>	The <b>RECD ACCT</b> (received on account) key is used to record media loaned to the cash drawer, or payments received outside of a sale. The cash drawer will open. The amount received adds to the cash-in-drawer total.
<b>SERVICE</b>	Use to temporarily finalise Previous Balance or Table Tracking transactions.
<b>SUBTOTAL</b>	Displays subtotal of sale including tax. Must be pressed prior to a sale discount or sale surcharge.
<b>TABLE #</b>	Tracks the current balance for a guest check or table.

<b>TAX EXEMPT</b>	Press the <b>TAX EXEMPT</b> key to exempt tax 1, tax 2, tax 3, and/or tax 4 from the entire sale.
<b>TAX (1-4) SHIFT</b>	When pressed before a PLU entry, the tax shift keys reverse the tax status of the PLU, i.e., a PLU with non-tax status would become taxable or a PLU with tax status would become non-taxable.
<b>TIP</b>	<p>The <b>TIP</b> key allows a gratuity to be added to a guest check before payment. The tip amount is deducted from the Cash-in-Drawer amount for the Clerk/Cashier closing the guest check.</p> <p>The <b>TIP</b> key may be programmed as either a percentage or amount. If programmed as a percentage, tax programming defines whether the percentage is calculated on the net amount or the amount after taxes.</p>
<b>VOID</b>	Use to correct an item entered earlier within a sale. The <b>VOID</b> key corrects the appropriate totals and counters. To correct the last item, use the <b>ERROR CORR</b> key. For void operations outside of a sale (Transaction Void), use the <b>VOID</b> position on the control lock. The Financial report records totals for each type of void separately.
<b>VALID</b>	Press the <b>VALID</b> key to print a one-line validation on a separate form or piece of paper. Any item registration, discount or payment may be validated.
<b>WASTE</b>	The <b>WASTE</b> key allows control of inventory by accounting for items, which must be removed from stock due to spoilage, breakage or mistakes. Press the <b>WASTE</b> key before entering wasted items, then press the <b>WASTE</b> key again to finalise. The <b>WASTE</b> key may be under manager control, requiring the control lock to be in the <b>X</b> position. The <b>WASTE</b> operation is not allowed within a sale.

---

## Clerk Sign-On/Sign-Off

See "System Option Programming", to review your clerk options:

- System option #2 allows you to select direct or code entry sign on and/or stay-down or pop-up operation.

Depending on how your machine has been programmed, sign-on will take place only at the beginning of a shift (stay-down), or may have to be repeated for each transaction (pop-up). If your machine has been programmed for stay-down clerks, the clerk currently signed on must be signed off before another clerk may be signed on.

### Direct Sign-On

To enter the clerk number and press the clerk .

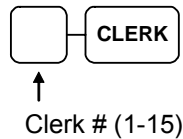

To sign the clerk off, Enter 0 (Zero) and press the clerk key .

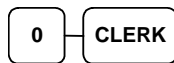

### Coded Sign-On

To sign on a clerk, press the clerk key, enter the clerk code, then press the clerk key again.

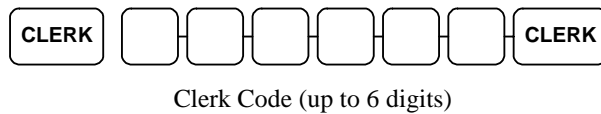

To sign the clerk off, enter 0 (Zero) and press the clerk key.

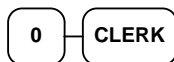

---

## Receipt On and Off

1. Turn the control lock to the **X** position.
2. To turn the receipt *off*, enter **9 9**, press the **SBTL** key. Enter **1**, press **CASH**.



3. To turn the receipt *on*, enter **9 9**, press the **SBTL** key. Enter **0**, press **CASH**.



---

## Item Registrations

All registrations on *ER-420M* are made into open or preset PLUs.

- In place of traditional PLU keys, some PLUs are located directly on the keyboard.
- When more items or categories are needed than the number of PLUs available on the keyboard, registrations through PLUs can be made by entering the PLU code number and pressing the **PLU** key on the keyboard.
- This system simplifies reporting by listing all items (regardless of how they are entered) on the PLU report, while reporting for groups of items or categories is available from the Group report.

## Open Keyboard PLU Entry

1. Enter an amount on the ten keypad. *Do not use the decimal key.* For example, for \$2.99, enter:



2. Press a PLU key. For example, press PLU 1:



THANK-YOU CALL AGAIN	
DATE 01/15/2003 WED	TIME 8:33
PLU1 T1	\$2.99
TAX1	\$0.18
TOTAL	\$3.17
CASH	\$3.17
	No.000011
CLERK 1	00001

## Preset Price Keyboard PLU

A preset PLU registers the price that was previously programmed for the PLU. See "PLU Programming" in the "Program Mode Programming" chapter to program preset prices.

1. Press a preset PLU key. For example, press PLU 5:

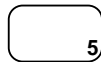

THANK-YOU CALL AGAIN	
DATE 01/15/2003 WED	TIME 8:33
PLU5	\$1.29
TOTAL	\$1.29
CASH	\$1.29
	No.000011
CLERK 1	00001

## Keyboard PLU Repeat Entry

Open or preset price PLUs can be repeated as many times as necessary by pressing the same PLU again. The number of times the item is repeated is shown on the display.

1. Enter an amount on the ten keypad. *Do not use the decimal key.* For example, for \$2.99, enter:

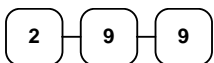

2. Press a PLU key. For example, press PLU 1:

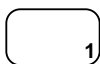

3. To register a second item exactly as the first, press the PLU key a second time. For example, press PLU 1:



THANK-YOU	
CALL AGAIN	
DATE 01/15/2003 WED	TIME 8:33
PLU1 T1	\$2.99
PLU1 T1	\$2.99
TAX1	\$0.36
TOTAL	\$6.34
CASH	\$6.34
	No.000011
CLERK 1	00001

## Keyboard PLU Multiplication

When several of the same items are to be sold of the same PLU, you can use multiplication. You can enter a quantity (1 to 999.999) using the **X/TIME** key. You can multiply open or preset PLUs.

1. Enter the quantity of items being purchased, press the **X/TIME** key. For example, enter **4** on the numeric key pad and press the **X/TIME** key:



2. Enter an amount on the ten keypad. *Do not use the decimal key.* For example, for \$1.99, enter:

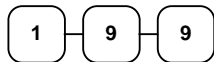

3. Press a PLU key. For example, press **PLU 1**:

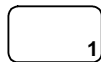

THANK-YOU	
CALL AGAIN	
DATE 01/15/2003 WED	TIME 08:33
4X	@1.99
PLU1 T1	\$7.96
TAX1	\$0.48
TOTAL	\$8.44
CASH	\$8.44
	No.000011
CLERK 1	00001



## Keyboard PLU Multiplication with Decimal Point

If you are selling items by weight, or decimal quantities such as half-pints, you can multiply a fraction of a unit.

1. Enter the amount with the decimal point, press the **X/TIME** key. For example, for 3.75 kilos of produce, enter:

3 . 7 5 X/TIME

2. Enter an amount on the ten keypad. *Do not use the decimal key.* For example, if the price is \$.99 per kilo, enter:

9 9

3. Press a PLU key. For example, press **PLU 1**:

1

THANK-YOU	
CALL AGAIN	
DATE 01/15/2003 WED	TIME 08:33
3.75X	@0.99
PLU1 T1	\$3.71
TAX1	\$0.22
TOTAL	\$3.93
CASH	\$3.93
	No.000011
CLERK 1	00001

## Split Pricing (Keyboard PLU)

When items are priced in groups, i.e. 3 for \$1.00, you can enter the quantity purchased and let the register calculate the correct price.

1. Enter the quantity purchased, press the **X/TIME** key. For example, enter:



2. Enter the quantity of the group price, press the **X/TIME** key. For example, if the items are priced 3 for \$1.00, enter:



3. Enter an amount on the ten keypad. For example, if the items are priced 3 for \$1.00, enter:

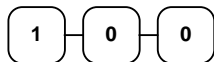

4. Press a PLU key. For example, press PLU 1:

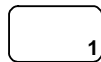

THANK-YOU	
CALL AGAIN	
DATE 01/15/2003 WED	TIME 08:33
2@3FOR	@1.00
PLU1 T1	\$0.67
TAX1	\$0.04
TOTAL	\$0.71
CASH	\$0.71
	No.000011
CLERK 1	00001

## Single Item Keyboard PLU

Single item PLUs automatically total as a cash sale immediately after registration. Use single item PLUs for speedy one-item sales. For example if you are selling admission tickets, and all ticket sales are one item sales, you can use an open or preset PLU. After each registration, the drawer will immediately open, and a separate transaction receipt is printed. See "PLU Programming" in the "Program Mode Programming" chapter to program a single item PLU.

1. Press a single item preset PLU key. (or enter a price and press a single item open PLU key.) For example, press PLU **6**:



THANK-YOU	
CALL AGAIN	
DATE 01/15/2003 WED	TIME 08:33
PLU6	\$1.29
TOTAL	\$1.29
CASH	\$1.29
	No.000011
CLERK 1	00001

## Open Code Entry PLU

If the PRESET status of a PLU is set to N (no), the PLU will operate as an open PLU. See "PLU Programming" in the "Program Mode Programming" chapter to program PLU descriptors and options.

1. Enter the PLU number; press the PLU key. For example, enter:



2. Enter an amount on the ten keypad. *Do not use the decimal key.* For example, for \$2.99, enter:

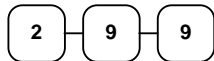

3. Press the **PLU** key again.



THANK-YOU	
CALL AGAIN	
DATE 01/15/2003 WED	TIME 08:33
PLU2 T1	\$2.99
TAX1	\$0.18
TOTAL	\$3.17
CASH	\$3.17
	No.000011
CLERK 1	00001

## Preset Price Code Entry PLU

1. Enter the PLU number; press the PLU key. For example, enter:



THANK-YOU	
CALL AGAIN	
DATE 01/15/2003 WED	TIME 08:33
PLU1	\$1.29
TOTAL	\$1.29
CASH	\$1.29
	No.000011
CLERK 1	00001

## Code Entry PLU Multiplication

When several of the same items are to be entered into the same PLU, you can use multiplication. You can enter a quantity (1 to 999.999) using the **X/TIME** key. You can multiply open or preset PLUs.

1. Enter the quantity of items being purchased, press the **X/TIME** key. For example, enter **4** on the numeric key pad and press the **X/TIME** key:



2. Enter the PLU number; press the **PLU** key. For example, enter:



THANK-YOU	
CALL AGAIN	
DATE 01/15/2003 WED	TIME 08:33
4X	@1.99
PLU1 T1	\$7.96
TAX1	\$0.48
TOTAL	\$8.44
CASH	\$8.44
	No.000011
CLERK 1	00001

## Code Entry PLU Multiplication with Decimal Point

If you are selling items by weight, or if you are selling yard goods, you can multiply a fraction of a unit.

1. Enter the quantity with the decimal point, press the **X/TIME** key. For example, for 3.75 Kilos of produce, enter:

3 . 7 5 X/TIME

2. Enter the PLU number; press the **PLU** key. For example, enter:

3 PLU

THANK-YOU		
CALL AGAIN		
DATE	01/15/2003 WED	TIME 08:33
3.75X	@2.99	
PLU3 T1		\$11.21
TAX1		\$0.67
TOTAL		\$11.88
CASH		\$11.88
		No.000011
CLERK 1		00001

## Split Pricing Code Entry PLU

When items are priced in groups, i.e. 3 for \$1.00, you can enter the quantity purchased and let the register calculate the correct price.

1. Enter the quantity purchased, press the **X/TIME** key. For example, enter:

2 X/TIME

2. Enter the quantity of the group price, press the **X/TIME** key. For example, if the items are priced 3 for \$1.00, enter:

3 X/TIME

3. Enter the PLU number; press the **PLU** key. For example, enter:

3 PLU

THANK-YOU		
CALL AGAIN		
DATE	01/15/2003 WED	TIME 08:33
2@3FOR	@2.99	
PLU3 T1		\$1.99
TAX1		\$0.12
TOTAL		\$2.11
CASH		\$2.11
		No.000011
CLERK 1		00001

## Modifier Key

Pressing a modifier key alters the next PLU registered, either by changing the code number of the PLU so that a different item is registered, or by just adding the modifier descriptor and registering the same PLU.

See "Modifier 1-5" in the "Program Mode Programming" chapter in order to determine how the modifier key will affect the PLU entry.

Modifiers can be:

- **STAY DOWN** so that registrations will be modified by the same modifier until another modifier is selected,
- **POP UP after each item** to register, for example large, medium or small soft drink,
- **POP UP after each transaction** to register, for example, toppings of various pizza sizes.

See "System Options" in the "Program Mode Programming" chapter to select stay down/pop-up status.

### Pop-Up Modifier Key Affecting PLU Code

1. Press a preset PLU key. For example, press PLU **1** with a price of \$1.00.



2. Press the **MOD 1** key.

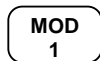

3. Press the same PLU key. In this example the modifier 1 will add the digit 1 to the fourth PLU # position, resulting in the registration of PLU #1001.

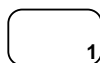

4. Press another PLU key. In this example press PLU **2** with a price of \$1.50.

THANK-YOU	
CALL AGAIN	
DATE 01/15/2003 WED	TIME 08:33
PLU1	\$1.00
MOD1	
#1001	\$1.25
PLU2	\$1.50
TOTAL	\$3.75
CASH	\$3.75
	No.000011
CLERK 1	00001

## Price Level Key

If you choose to use the price level feature, you must allocate memory for each level. See "Memory Allocation" in the "Service Mode Programming" chapter. Note that the default program selects one price level. You must also place price level keys on the keyboard. See "Function Key Assignment" in the "Program Mode Programming" chapter.

If you use this feature, the same PLU can be given up to 2 different preset prices. Price Level keys shift the price that is being registered. Levels can be:

- **STAY DOWN** so that registrations will stay in the selected level until **another is selected**,
- **POP UP after each item** to register, for example large, medium or small soft drink,
- **POP UP after each transaction** to register, for example, toppings of various pizza sizes.

See "System Options" in the "Program Mode Programming" chapter to set how the price level keys operate.

### Pop-Up Price Level Keys

1. Press a preset PLU key. For example, press PLU 1 programmed with a price of \$1.00 for price level 1.



2. Press the **LEVEL 2** key. The message "LEVEL 2" displays.



3. Press the same PLU key. In this example the PLU 1 key is programmed with a price of \$2.00 for price level 2.



4. Press another PLU key. In this example press PLU 2 programmed to register PLU #2 with price level 1. Note that the level 1 price is registered.

THANK-YOU	
CALL AGAIN	
DATE 01/15/2003 WED	TIME 08:33
PLU1	\$1.00
PLU1	\$2.00
PLU2	\$1.50
TOTAL	\$4.50
CASH	\$4.50
	No.000011
CLERK 1	00001



## PROMO

The **PROMO** key allows you to account for promotional items. Pressing this key will remove an item's cost from the sale, and the **PROMO** item will not be added to the PLU sales total, but it is added to the item sales counter. If stock (inventory) reporting is used, the item will be subtracted from inventory.

1. Register an item. For example, press **PLU 1** programmed with a price of \$1.00 for price level 1.

2. Press the **PROMO** key. The message "**PROMO**" displays.

3. Enter the item to be **Promoted**. You can not enter an item that has not been already registered in this transaction.

THANK-YOU	
CALL AGAIN	
DATE 01/15/2003 WED	TIME 08:33
PLU1	\$1.00
***PROMO***	
PLU1	
TOTAL	\$0.00
CASH	\$0.00
	No.000011
CLERK 1	00001

## Waste

The **WASTE** key allows control of inventory by accounting for items that must be removed from stock due to spoilage, breakage or mistakes. Press the **WASTE** key before entering wasted items, and then press the **WASTE** key again to finalise. The **WASTE** key may be under manager control, requiring the control lock to be in the **X** position. The **WASTE** key is not allowed within a sale.

1. Press the **WASTE** key. The message "WASTE" displays at the top of the screen.

**WASTE**

2. Enter the item or items that are wasted.
3. Press the **WASTE** key again to total the wasted items:

**WASTE**

THANK-YOU CALL AGAIN	
DATE 01/15/2003 WED	TIME 08:33
***WASTE***	
PLU1	\$1.25
PLU2	\$1.50
***WASTE***	
TOTAL	\$2.75
	No.000011
CLERK 1	00001

## KBD SHIFT

The **KBD SHIFT** key allows you to expand the NLU keys on the keyboard. You can use this key by 3 levels.

Level 1 : NLU key(1~12) \* 1;

Level 2 : NLU key(1~12) \* 2;

Level 3 : NLU key(1~12) \* 3;

1. Press the NLU key. For example, enter:

12

2. Enter the level number(1~3);press the KBD SHIFT key. For example, enter:

2 KBD SHIFT

3. Press the same NLU key. For example, enter:

12

THANK-YOU	
CALL AGAIN	
DATE 01/15/2003 WED	TIME 08:33
PLU 12	\$1.00
PLU 24	\$2.00
TOTAL	\$3.00
CASH	\$3.00
	No.000011
CLERK 1	00001

---

## Percent Key Operations

A total of five % functions are available to be allocated to the keyboard.

Each function is individually programmable to add or subtract, from an individual item or from a sale total, amounts (coupons) or percentages. You can also program the percentage key taxable or non-taxable, so that sales taxes are calculated on the net, or the gross amount of the item or sale. You can also program preset prices or percentages.

The operation examples in this section show the percentage key in a variety of configurations. See "Function Key Programming" in the "Program Mode Programming" chapter to assign a specific function to each percentage key.

### Preset Percent Discount on an Item

In this example the %1 function is preset with a rate of 10 %.

1. Register the item.
2. Press the %1 key:

**% 1**

3. The discount is automatically subtracted.

THANK-YOU	
CALL AGAIN	
DATE 01/15/2003 WED	TIME 08:33
PLU2	\$10.00
% 1	-10.000%
AMOUNT	-1.00
TOTAL	\$9.00
CASH	\$9.00
	No.000011
CLERK 1	00001

## Enter a Percent Discount on an Item

You can also operate the percentage functions by entering the percentage of the discount or surcharge. If necessary, you can enter a fractional percentage up to 3 digits beyond the decimal (i.e. 99.999%).

1. Register the discounted item.
2. Enter the percentage. If you are entering a fraction of a percent, you must use the decimal key. For example, for one third off enter:

3 3 . 3 3 3

3. Press the %1 key:

% 1

4. The discount is automatically subtracted.

THANK-YOU CALL AGAIN	
DATE 01/15/2003 WED	TIME 08:33
PLU2	\$10.00
% 1	-33.333%
AMOUNT	-3.33
TOTAL	\$6.67
CASH	\$6.67
	No.000011
CLERK 1	00001

## Percent on Sale Total

The percent can be an open or preset amount. In this example an open percentage surcharge of 15% is applied.

1. Register the items you wish to sell.
  2. Press the **SBTL** key:
- SBTL
3. Enter the percentage, press the appropriate discount key. For example, for 15% enter:

1 5 %1

4. The surcharge is automatically added.

THANK-YOU CALL AGAIN	
DATE 01/15/2003 WED	TIME 08:33
PLU2	\$10.00
% 1	15.000%
AMOUNT	\$1.50
TOTAL	\$11.50
CASH	\$11.50
	No.000011
CLERK 1	00001

## Coupon on Sale (Vendor Coupon)

When programmed as "amount", "sale", "open" and "negative", a % key will perform a coupon against a sale (or vendor coupon.) Also, depending upon programming:

- You may be allowed to enter only one coupon in a sale, after the **SBTL** key is pressed,
- You may be allowed to enter multiple coupons, but you must press the **SBTL** key before each coupon,
- You may be allowed to enter multiple coupons, without first pressing **SBTL**.

In this example, a coupon may be entered only once, and you must first press **SBTL**.

1. Register the items you wish to sell.

2. Press the **SBTL** key:

**SBTL**

3. Enter the amount of the coupon, press the appropriate % key. For example:

2 0 0 % 1

4. The coupon is subtracted.

THANK-YOU	
CALL AGAIN	
DATE 01/15/2003 WED	TIME 08:33
PLU2	10.00
%1	2.00
TOTAL	\$8.00
CASH	\$8.00
	No.000011
CLERK 1	00001

## Coupon on Item (Store Coupon)

When programmed as "amount", "item", "open" and "negative", a % key will perform a coupon against an item (or store coupon.) In this case, you must press the PLU (or enter the PLU number) of the PLU you wish the coupon to be subtracted from.

1. Register the items you wish to sell.
2. Enter the amount of the coupon, press the appropriate % key. For example:

2 0 0 % 1

3. Press the PLU key you wish to subtract the coupon from (or enter the PLU number of the PLU you wish to subtract the coupon from and press **PLU**.)

1

4. The coupon is automatically subtracted.

THANK-YOU	
CALL AGAIN	
DATE 01/15/2003 WED	TIME 08:33
PLU1	\$10.00
PLU1 C	-2.00
TOTAL	\$8.00
CASH	\$8.00
	No.000011
CLERK 1	00001

---

## Return Merchandise Registrations

If you wish to return or refund an item, press **RETURN**, then re-enter any item. You can return merchandise as part of a sale, or you can return merchandise as a separate transaction and return cash to the customer.

1. Press **RETURN**:

**RETURN**

2. Enter the price of the item you wish to return, then press the PLU key where it was registered originally.

2 9 9 2

3. Total the sale with **CASH**, **CHECK**, or a **CHARGE** function.

THANK-YOU	
CALL AGAIN	
DATE 01/15/2003 WED	TIME 08:33
RETURN *****	
PLU2 T1	2.99
TAX1 AMT	0.18
TOTAL	3.17
CASH	3.17
	No.000011
CLERK 1	00001



---

# Voids and Corrections

## Error Correction (Void Last Item)

This function corrects the last item entered.

1. Register the item you wish to sell.
2. Press the **ERROR CORR** key:



THANK-YOU	
CALL AGAIN	
DATE 01/15/2003 WED	TIME 08:33
PLU1 T1	\$2.29
PLU2	\$1.29
ERR CORR -----	
PLU2	1.29
TAX1 AMT	\$0.14
TOTAL	\$2.43
CASH	\$2.43
	No.000011
CLERK 1	00001

## Void Previous Item

This function allows you to correct an item registered previously in a transaction.

1. Register an item. Then register a second item.
2. To correct the first item, press **VOID:**



3. Enter the price of the first item, then press the PLU key where it was registered originally.

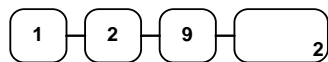

THANK-YOU	
CALL AGAIN	
DATE 01/15/2003 WED	TIME 08:33
PLU2	\$1.29
PLU1 T1	\$2.29
VOID -----	
PLU2	-1.29
TAX1 AMT	\$0.14
TOTAL	\$2.43
CASH	\$2.43
	No.000011
CLERK 1	00001

## Cancel

The **CANCEL** key allows you to stop any transaction. Anything registered within the transaction before the **CANCEL** key is pressed is automatically corrected. The **CANCEL** key can be inactivated through programming, see "Function Key Programming" in the "Program Mode Programming" chapter, or the key can be programmed to require manager control.

1. Register the items you wish to sell.
2. Press the **CANCEL** key

**CANCEL**

```
THANK-YOU
CALL AGAIN

DATE 01/15/2003 WED    TIME 08:33

PLU1 T1                $2.29
PLU2                   -0.50
CANCEL *****
                               No.000011
CLERK 1                00001
```

## Void Position Operations

You can use the **VOID** control lock position to correct any complete transaction. To correct any transaction:

1. Turn the control lock to the **VOID** position.
2. Enter the transaction you wish to correct exactly as it was entered originally in the **REG** control lock position. You can enter discounts, voids, returns, tax exemptions or any other function.
3. All totals and counters are corrected as if the original transaction did not take place.

```
THANK-YOU
CALL AGAIN

DATE 01/15/2003 WED    TIME 08:33

VOID MODE *****
PLU1 T1                -2.29
PLU2                   -1.00
TAX1 AMT               -0.14
TOTAL                  -3.43
CASH                   -3.43
                               No.000011
CLERK 1                00001
```

---

# No Sale Operations

## Open Drawer

The **#/NO SALE** key will open the cash drawer when you have not already started a transaction. The no sale function can be disabled or placed under manager control through programming, see "Function Key Programming" in the "Program Mode Programming" chapter.

1. Press **#/NS**:



2. The drawer will open and the receipt will print as in the example on the right.

THANK-YOU CALL AGAIN	
DATE 01/15/2003 WED	TIME 08:33
NO SALE -----	
	No.000011
CLERK 1	00001

## Non Add Number

You can also use the **#/NO SALE** key to print any number (up to 9 digits) on the printer paper. You can enter the number any time during a transaction. For example, if you wish to record a checking account number, enter the number and press the **#/NO SALE** key before totalling the sale with the **CHECK** key.

1. Register the items you wish to sell.
2. Enter the number you wish to record, for example enter:



3. Press **#/NS**:



4. Press **CHECK**



THANK-YOU CALL AGAIN	
DATE 01/15/2003 WED	TIME 08:33
PLU1 T1	\$2.99
NON-ADD#	1234
TAX1 AMT	\$0.18
TOTAL	\$3.17
CHECK	\$3.17
	No.000011
CLERK 1	00001

---

## Received On Account Operations

You can use one of the received on account functions (**RA1-RA3**) to accept cash or checks into the cash drawer when you are not actually selling merchandise. For example, use received on account to accept payments for previously sold merchandise, or record loans to the cash drawer.

1. Press one of the received on account keys (**RA1-RA3**)

RA1

2. Enter the amount of cash received, press **CASH**.

1 0 0 0 CASH

3. Enter the CHECK amount received, press **CHECK**

1 0 0 0 CHECK

4. Enter the charge amount received, press **CHARGE1**

1 0 0 0 CHARGE 1

5. You can continue to itemise receipts, or you can finalise by pressing or selecting the same received on account key.

RA1

THANK-YOU CALL AGAIN	
DATE 01/15/2003 WED	TIME 08:33
RA1	
CASH	\$10.00
CHECK	\$10.00
CHARGE1	\$10.00
RA1	\$30.00
	No.000011
CLERK 1	00001

---

## Paid Out Operations

You can use the paid out function(**PO1-PO3**) to track cash or checks paid out or to record loans from the cash drawer.

1. Press one of the paid out keys(**PO1-PO3**)

**PO1**

2. Enter the amount of cash paid out, press **CASH**.

1 0 0 0 **CASH**

3. Enter the CHECK amount paid out, press **CHECK**.

1 0 0 0 **CHECK**

4. Enter the charge amount received, press **CHARGE1**

1 0 0 0 **CHARGE 1**

5. You can continue to itemize paid outs, or you can finalise by pressing or selecting the same paid out key.

**PO1**

THANK-YOU CALL AGAIN	
DATE 01/15/2003 WED	TIME 08:33
PO1	
CASH	10.00
CHECK	10.00
CHARGE1	10.00
PO1	30.00
	No.000011
CLERK 1	00001

---

## Subtotalling a Sale

1. Register the items you wish to sell.
2. Press **SBTL**. The subtotal will display with the message "Sub" indicated on the rear display.



The subtotal can be printed if the system option is set. See "Print Option Programming" in the "Program Mode Programming" chapter.

---

## Totalling and Tendering

There are ten tender functions available to categorise sales. **CASH** and **CHECK** are individual keys on the keyboard

### Totalling a Cash Sale

1. Register the items you wish to sell.
2. To total a cash sale, press **CASH**:

**CASH**

3. The display will indicate the total amount of the cash sale.

THANK-YOU	
CALL AGAIN	
DATE 01/15/2003 WED	TIME 08:33
PLU2	\$7.96
TOTAL	\$7.96
CASH	\$7.96
	No.000011
CLERK 1	00001

### Totalling a CHECK Sale

1. Register the items you wish to sell.
2. To total a cash sale, press **CHECK**:

**CHECK**

3. The display will indicate the total amount of the cash sale.

THANK-YOU	
CALL AGAIN	
DATE 01/15/2003 WED	TIME 08:33
PLU2	\$7.96
TOTAL	\$7.96
CHECK	\$7.96
	No.000011
CLERK 1	00001

## Tendering a Cash Sale

1. Register the items you wish to sell.
2. Enter the amount tendered by the customer. For example, for \$20.00 enter:

2 0 0 0

3. Press **CASH**:

CASH

4. The display will indicate the total amount of the cash tendered and the change due, if any.

THANK-YOU		CALL AGAIN	
DATE	01/15/2003 WED	TIME	08:33
PLU1	T1		\$2.99
PLU1	T1		\$2.99
4X		\$1.99	
PLU2			\$7.96
TAX1			\$0.36
TOTAL			\$14.30
CASH			\$20.00
CHANGE			\$5.70
		No.	000011
CLERK	1		00001

## Tendering a CHECK Sale

1. Register the items you wish to sell.
2. Enter the amount tendered by the customer. For example, for \$20.00 enter:

2 0 0 0

3. Press **CHECK**:

CHECK

4. The display will indicate the total amount of the check tendered and the change due, if any.

THANK-YOU		CALL AGAIN	
DATE	01/15/2003 WED	TIME	08:33
PLU1	T1		\$2.99
PLU1	T1		\$2.99
4X		\$1.99	
PLU2			\$7.96
TAX1			\$0.36
TOTAL			\$14.30
CHECK			\$20.00
CHANGE			\$5.70
		No.	000011
CLERK	1		00001



## Totalling a Charge Sale

Use the charge keys to track charge or credit card sales. See "Function Key Programming" in the "Program Mode Programming" chapter to change the descriptors for the charge tender functions. For example, you can use CHARGE 1 to track Visa card sales. The descriptor "VISA" will display on the function look up menu and print on the printer. You can also set tendering options for the charge keys, i.e. whether to allow over tendering or to enforce tendering.

1. Register the items you wish to sell.
2. Press one of the charge keys if it is located on the keyboard:



THANK-YOU	
CALL AGAIN	
DATE 01/15/2003 WED	TIME 08:33
PLU1 T1	\$2.99
PLU1 T1	\$2.99
4X	\$1.99
PLU2	\$7.96
TAX1	\$0.36
TOTAL	\$14.30
CHARGE1	\$14.30
	No.000011
CLERK 1	00001

## Tendering a Charge Sale

Tendering a charge sale may or may not be allowed. See "Function Key Programming" in the "Program Mode Programming" chapter to set tendering options for the charge keys, i.e. whether to allow over tendering or to enforce tendering.

1. Register the items you wish to sell.
2. Enter the amount of the charge and press one of the charge keys if it is located on the keyboard:

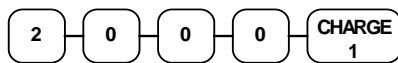

THANK-YOU	
CALL AGAIN	
DATE 01/15/2003 WED	TIME 08:33
PLU1 T1	\$2.99
PLU1 T1	\$2.99
4X	\$1.99
PLU2	\$7.96
TAX1	\$0.36
TOTAL	\$14.30
CHARGE1	\$20.00
CHANGE	\$5.70
	No.000011
CLERK 1	00001

## CHECK Cashing

CHECK cashing means exchanging cash for a CHECK. If you wish to cash CHECKS, you must place a **CHKCASH** key on the keyboard. See "Function Key Assignment" in the "Program Mode Programming" chapter.

1. Enter the amount of the CHECK tendered by the customer. For example, for \$20.00 enter:

2 0 0 0

2. Press **CHKCASH**:

CHK  
CASH

3. The display will indicate the amount of the CHECK and the cash change.

```
THANK-YOU
CALL AGAIN

DATE 01/15/2003 WED   TIME 08:33

***CHKCASH***

CHECK                $20.00
CASH                 -20.00
                   No.000011
CLERK 1              00001
```

## Split Tender

Split tendering is paying for one transaction by more than one payment method. For example, a \$20.00 sale could be split so \$10.00 is paid in cash, and the remaining \$10.00 is paid by a CHECK. If necessary, you can make several different payments.

1. Register the items you wish to sell.
2. Enter the amount of cash tendered by the customer. For example, enter \$10.00 and press **CASH**:

1 0 0 0 CASH

3. The display will indicate the \$10.00 cash tender and the \$10.00 total still due.
4. Enter the amount of CHECK tendered by the customer. For example, enter \$10.00 and press **CHECK**:

1 0 0 0 CHECK

5. When the total tendered equals or exceeds the total due, the receipt will print and the transaction is complete.

THANK-YOU CALL AGAIN	
DATE 01/15/2003 WED	TIME 08:33
PLU2	\$20 00
TOTAL	\$20.00
CASH	\$10.00
TOTAL	\$10.00
CHECK	\$10.00
	No.000011
CLERK 1	00001

## Post Tender

Post tendering means computing change after the sale has been totalled and the drawer is open. This feature is useful when a customer changes the amount of the tender. Normally, this function is not allowed. If you wish to allow post tendering, you must set the appropriate system option.

1. Register the items you wish to sell.
2. Press **CASH**:

**CASH**

3. The display will indicate the total of the cash sale.
4. Enter the amount of the new tender,  
Press **CASH**:

**2** **0** **0** **0** **CASH**

5. The display will indicate the change due.

THANK-YOU	
CALL AGAIN	
DATE 01/15/2003 WED	TIME 08:33
PLU1 T1	\$2.00
TAX1	\$0.12
CASH	\$2.12
	No.000011
CLERK 1	00001

## Currency Conversion

If you normally accept currency from neighbouring nations, you can program to convert the subtotal of a sale to the equivalent cost in the foreign currency. You can set up four separate conversion functions for different foreign currencies. To do this, you need to program the conversion factor. For example, if the pound (home currency) is worth approximately 63 euros (foreign currency), the conversion factor could be 0.632511.

See "Function Key Programming" in the "Program Mode Programming" chapter to set a conversion factor.

1. Register the items you wish to sell.
2. Press the **CONV1** key if it is located on the keyboard:



3. Enter the amount of the foreign currency tender, Press **CASH**:

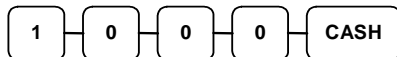

4. The display will indicate the amount of foreign currency tendered and display \$5.17 change due. The change due is computed in home currency!

THANK-YOU	
CALL AGAIN	
DATE 01/15/2003 WED	TIME 08:33
PLU1 T1	\$2.00
TAX1	\$0.12
TOTAL	\$2.12
CONV 1	€2.90
CHANGE RATE	@1.3720
HOME AMT.	\$10.00
CHANGE	\$5.17
	No.000011
CLERK 1	00001

---

# Table Management and Clerk Interrupt Operations

## Overview

The *ER-420M* can employ a manual previous balance, hard check, or soft check system. (You must select hard or soft check posting in memory allocation programming - the default selection is soft.)

There are two methods in *ER-420M* to manage check track. One is table management system and the other is clerk interrupt system. If you want to use clerk interrupt system. First, Program as below.

### To Enter Clerk Interrupt System (To Exit Table Management system )

1. Program Clerk Secret Code
2. Set system option #2 to a value of **1**. See “System Option Programming”
3. Set system option #26 to a value of **1**. See “System Option Programming”.

### To Exit Clerk Interrupt System (To Enter Table Management system)

Set system option #26 to a value of **0**. See “System Option Programming” .

## Soft Check

### Opening a Soft Check

1. Enter the number of the guest check, press the **CHECK #** key:

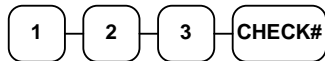

or, press the **CHECK #** key to automatically assign a check:



2. If required, enter the table number and press the **TABLE** key:



3. If required, enter the number of guests and press the **GUEST** key:



4. Register the items you wish to sell.
5. To total the posting, press **SERVICE**:



### Receipt Example:

THANK-YOU CALL AGAIN	
DATE 01/15/2003 WED	TIME 08:33
CHECK #	<b>#123</b>
PBAL	\$0.00
TABLE	#3
GUEST	#2
CHICKEN	\$7.00
STEAK	\$10.00
SERVICE	\$17.00
BFWD	<b>\$17.00</b>
	No.000011
CLERK 1	00001

---

Note: If a table number entry is required for all guest checks, and checks are assigned by register, the check will be assigned by the register when the table # is entered.

---



### Adding to a Soft Check

1. Enter the number of the guest check, press the **CHECK #** key:

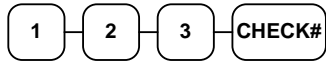

or, if you entered a table number, enter the table number and press the **TABLE** key:



2. Register the next items you wish to sell.
3. To total the posting, press **SERVICE**:



### Printing a Soft Check

1. Enter the number of the guest check, press the **CHECK #** key:

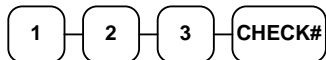

or, if you entered a table number, enter the table number and press the **TABLE** key:



2. Press **PRINT CHECK** to print the complete check. If programmed to do so, the **PRINT CHECK** key will automatically service the check:



### Receipt Example:

THANK-YOU CALL AGAIN	
DATE 01/15/2003 WED	TIME 08:33
CHECK #	<b>#123</b>
PBAL	\$17.00
TABLE	#3
GARLIC BREAD	\$2.00
SERVICE	\$2.00
BFWD	<b>\$19.00</b>
	No.000012
CLERK 1	00001

### Sample of soft check printed on the receipt:

THANK-YOU CALL AGAIN	
DATE 01/15/2003 WED	TIME 08:33
CHECK #	<b>#123</b>
PBAL	\$19.00
TABLE	#3
CHICKEN	\$7.00
STEAK	\$10.00
GARLIC BREAD	\$2.00
SERVICE	\$0.00
BFWD	<b>\$19.00</b>
	CHK # : 1
	No.000012
CLERK 1	00001

### Part Paying a Soft Check (ONLY if Payment Key Compulsory)

1. Enter the number of the guest check, press the **CHECK #** key:

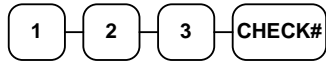

or, if you entered a table number, enter the table number and press the **TABLE** key:



2. If necessary, add additional items.

Pay the balance as you would normally tender a transaction, with **CASH**, **CHECK**, or one of the **CHARGE** functions.

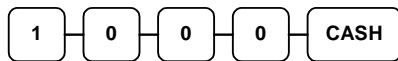

3. To finalise the part paying, press **SERVICE**:



Sample of soft check printed on the receipt:

THANK-YOU CALL AGAIN	
DATE 01/15/2003 WED	TIME 08:33
CHECK #	<b># 1 2 3</b>
PBAL	\$19.00
TABLE	#3
CHECKS PAID	\$10.00
CASH	\$10.00
SERVICE	\$9.00
	CHK # : 2
	No.000013
CLERK 1	00001

### **Paying (Finalising) a Soft Check**

1. Enter the number of the guest check, press the **CHECK #** key:

1 — 2 — 3 — CHECK#

or, if you entered a table number, enter the table number and press the **TABLE** key:

3 — TABLE

2. If necessary, add additional items. If you wish to add a tip, press **SBTL**, then enter the tip amount and press the **TIP** key:

SBTL

3 — 0 — 0 — TIP

3. If Payment key is compulsory Press Payment to confirm Soft Check will be Finalised

PAYMENT

4. Pay the balance as you would normally tender a transaction, with **CASH**, **CHECK**, or one of the **CHARGE** functions. If the tender is greater than the balance due, change is displayed.

2 — 5 — 0 — 0 — CASH

Sample of soft check printed on the receipt:

THANK-YOU CALL AGAIN	
DATE 01/15/2003 WED	TIME 08:33
CHECK #	<b>#123</b>
PBAL	\$19.00
TABLE	#3
TIP	\$3.00
CHECKS PAID	\$22.00
CASH	\$25.00
CHANGE	\$3.00
	CHK # : 2
	No.000013
CLERK 1	00001

## Hard Check

### Opening a Hard Check

1. Enter the number of the guest check, press the **CHECK #** key:

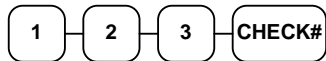

or, press the **CHECK #** key to automatically assign a check:



2. If required, enter the table number and press the **TABLE** key:



3. If required, enter the number of guests and press the **GUEST** key:



4. Register the items you wish to sell.
5. Place a slip in an optional slip printer, the check will print automatically when you press **SERVICE**:



### Receipt Example:

THANK-YOU CALL AGAIN	
DATE 01/15/2003 WED	TIME 08:33
CHECK #	<b>#123</b>
PBAL	\$0.00
TABLE	#3
GUEST	#2
CHICKEN	\$7.00
STEAK	\$10.00
SERVICE	\$17.00
BFWD	<b>\$17.00</b>
	No.000011
CLERK 1	00001

### **Adding to a Hard Check**

1. Enter the number of the guest check, press the **CHECK #** key:

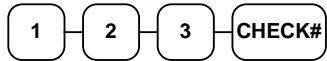

or, if you entered a table number, enter the table number and press the **TABLE** key:



2. Register the next items you wish to sell.
3. To total the posting, press **SERVICE**:



### Receipt Example:

THANK-YOU CALL AGAIN	
DATE 01/15/2003 WED	TIME 08:33
CHECK #	<b>#123</b>
PBAL	\$17.00
TABLE	#3
GARLIC BREAD	\$2.00
SERVICE	\$2.00
BFWD	<b>19.00</b>
	No.000012
CLERK 1	00001

# X/Z Mode

---

## Introduction

All Management Functions take place with the control lock in the **X** position. This way only those with the correct key will have access to these functions. Some register operations may be programmed to require the control lock in the **X** position in order to operate. All reports require a key that will access the **X** or **Z** position.

---

## X Reports

System reports are divided into two basic categories:

- **X** reports, which read totals without resetting
- **Z** reports, which read totals and reset them to zero

Most reports are available in both categories. Some reports, such as the Cash-in-Drawer report and the From-To PLU report are available only as **X** reports.

Some reports also provide identical but separate *period to date* reports. These reports maintain a separate set of totals, which may be allowed to accumulate over a period of days, weeks, months, or even years. **X2** reports read period to date totals without resetting, and **Z2** reports read period to date totals and reset them to zero. Period to date totals are updated each time a **Z1** report is completed.

A complete list of available reports is presented in a chart on the following page.

An example is given for each of these reports in the pages that follow. Those reports which may be optionally abbreviated through register programming are represented twice. They are first shown with the option off, giving all totals, and again with the option turned on, showing the abbreviated version of the same report.

Registers programmed with pop-up clerks must be signed on in the **REG** control lock position prior to taking reports.

### Running a Report – General Instructions

1. Refer to the “Report Table”.
2. Select a report type and the report mode.
3. Turn the control lock to the position indicated.
4. Enter the key sequence for the report you have selected.

## Report Table

Report Type	Report Number	Report Mode	Control Lock Position	Key Sequence
<b>Financial</b>	1	X	X	1 – SBTL
		Z	Z	1 – SBTL
		X2	X	201 – SBTL
		Z2	Z	201 – SBTL
<b>Time</b>	2	X	X	2 – SBTL
		Z	Z	2 – SBTL
		X2	X	202 – SBTL
		Z2	Z	202 – SBTL
<b>All PLU</b>	3	X	X	3 – SBTL
		Z	Z	3 – SBTL
		X2	X	203 – SBTL
		Z2	Z	203 – SBTL
<b>All Clerk</b>	4	X	X	4 – SBTL
		Z	Z	4 – SBTL
		X2	X	204 – SBTL
		Z2	Z	204 – SBTL
<b>Group</b>	5	X	X	5 – SBTL
		Z	Z	5 – SBTL
		X2	X	205 – SBTL
		Z2	Z	205 – SBTL
<b>All STOCK</b>	6	X	X	6 – SBTL
		Z	Z	6 – SBTL
<b>Daily Sales</b>	8	X2	X	208 – SBTL
		Z2	Z	208 – SBTL
<b>Individual Clerk Report</b>	9	X	X	9-SBITL-#-CLERK-#-CLERK
		X2	X	209-SBITL-#-CLERK-#-CLERK
<b>Open Table</b>	11	X	X	11 – SBTL
		Z	Z	11 – SBTL
<b>From/To PLU</b>	13	X	X	13-SBTL XXXX – PLU – XXXX – PLU
<b>From/To PLU</b>		X2	X	213-SBTL XXXX – PLU – XXXX – PLU
<b>From/To STOCK</b>	14	X	X	14-SBTL XXXX –PLU – XXXX – PLU
<b>DRAWER TOTAL</b>	111	X	X	111-SBTL



---

## Reset Hard Check Line #

If you want to change hard check line # to specific value, follow below sequence in **Z mode**.

1. Reset **All** Hard Check Line #.



2. Reset **an Individual** Hard Check Line #.



---

## Cash Declaration

If compulsory cash declaration is required, you must declare the count of the cash drawer prior to taking **X** or **Z** financial and clerk reports.

You can enter the cash drawer total in one step, or to facilitate the counting of the cash drawer, you can enter each type of bill/coin and **CHECKS** separately and let the register act as an adding machine. You can also use the **X/TIME** key to multiply the denomination of currency times your count.

Either way you choose to enter cash, the register will compare your declaration with the expected cash and **CHECK** in drawer totals and print the over or short amounts on the report.

For example:

1. Turn the control lock to the **X** or **Z** position (depending upon the type of report you are taking.)

2. Press the **SBTL** key.



3. Enter the total of cash.

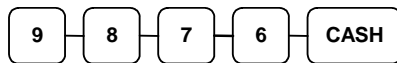

4. Enter the total of **CHECKS**.

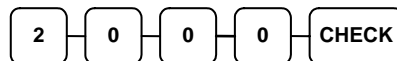

5. Press the **CASH** key to total the declaration.

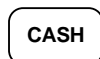

THANK-YOU CALL AGAIN			
DATE	01/15/2003	WED	TIME 08:33
*** CASH DECLARATION **			
CASH			\$98.76
CHECK			\$20.00
INPUT AMT			\$118.76
DRAWER TTL			\$118.76
DIFFERENCE			\$0.00
		No.	000011
CLERK 1			00001

# Service Mode Programming

---

## Overview

The following procedures are done from the Service Mode menu:

- Clear all totals
- Clear grand total
- Clear PLU file
- EPROM Information
- Memory Allocation
- Assignment of functions to keyboard locations
- RS232C Port

---

## Memory Allocation Scan

1. Turn the control lock to the S position to scan the allocated memory .
2. Enter **60**, press the **SBTL** key.

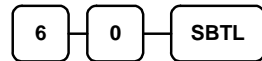

3. Press CASH key

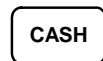

---

## PC Online Mode

In *ER-420M*, There are no special commands to enter PC Online Mode.

When you want to enter PC Online mode, all you have to do is to set 232 Communication Option in Programming. When PC sends commands to the ECR, the ECR will be automatically in Online Mode if connected.

# Memory Allocation

1. Turn the control lock to the S position.
2. To Allocate Memory, enter **60**, press the **SBTL** key.

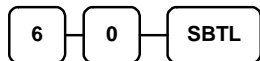

3. Refer to the chart below. Enter the index number and press the **X/TIME** key.

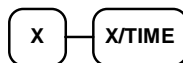

X	MEMORY ITEM
1	PLU
2	CLERK
3	GROUP
4	CHECK#
5	SOFT CHECK LINE
6	CHECK TYPE : Hard(1), Soft(0)
7	PRICE LEVEL
8	MIX AND MATCH

4. Enter the Number to allocate for the Memory Item and Press **CASH** key.  
See the example data table below

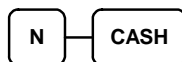

MEMORY ITEM	N
<b>PLU</b>	1000 (Max.9000)
<b>CLERK</b>	15 (Max. 99)
<b>GROUP</b>	20 (Max. 99)
<b>CHECK #</b>	20 (Max. 500)
<b>SOFT CHECK LINE</b>	50 (Max. 100)
<b>CHECK TYPE</b>	0(Soft Check), 1(Hard Check)
<b>PRICE LEVEL</b>	1 (Max. 2)
<b>MIX AND MATCH</b>	20 (Max. 99)

Default Memory Allocation

5. If you want to finish memory allocation, Enter CASH key with no numeric key input. And If you want to allocate Another memory area, Repeat 3,4 STEP.



---

## Clear Totals

1. Turn the control lock to the S position.
2. To Reset Totals, enter **20**, press the **SBTL** key.

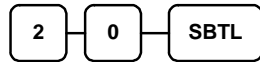

---

## Clear Grand Totals

1. Turn the control lock to the S position.
2. To Reset Grand Totals, enter **30**, press the **SBTL** key.

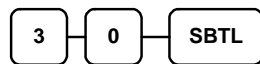

---

## Clear PLU File

1. Turn the control lock to the S position.
2. To Reset PLU file, enter **40**, press the **SBTL** key.

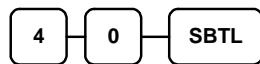

---

## Eprom Information

1. Turn the control lock to the S position.
2. To Scan Eprom Information, enter **50**, press the **SBTL** key.

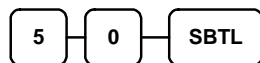

---

## Function Key Assignment Programming

Function keys may be relocated, inactivated or changed with this program. For example, you may wish to place functions, such as PREVIOUS BALANCE and SERVICE that are not placed on the default keyboard. Or perhaps, you may wish to remove a function, such as CANCEL, for security reasons.

Please note the following limitations:

- If you assign a duplicate of a function code, the duplicate will function exactly as the original - you will not get separate totals and counters on reports for the duplicated key.
- You can reassign keys only in locations that are programmable. See "Keyboards", where the key locations that may be programmed are identified.

### ***To Assign a Function Key to a Location:***

1. Turn the control lock to the **S** position.
2. Enter 70, press the **SBTL** key.

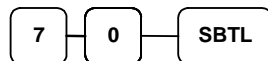

3. Refer to Function Key Codes to find the code for the key you wish to assign, press the location you wish to program. Repeat this step to assign another key.

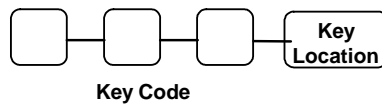

4. Press the CASH key to finalise key assignment program.

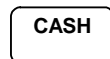

## Function Key Codes

Code	Function	Code	Function	Code	Function	Code	Function
1	NLU 1	147	CHARGE 6	177	MACRO 8	207	TIP
50	NLU 50	148	CHARGE 7	178	MACRO 9	208	VOID ITEM
51-119	Reserved	149	CHARGE 8	179	MACRO 10	209	WASTE
120	Numeric 1	150	CHECK CASHING	180	MDSE RETURN	210	VALIDATION
121	Numeric 2	151	ENDORSE	181	MODIFIER 1	211	PAYMENT
122	Numeric 3	152	CHECK TEND	182	MODIFIER 2	212	RCPT ON/OFF
123	Numeric 4	153	CHECK #	183	MODIFIER 3	213	J FEED
124	Numeric 5	154	CLEAR (ESC)	184	MODIFIER 4	214	INACTIVE
125	Numeric 6	155	CLERK #	185	MODIFIER 5	215	NON ADD
126	Numeric 7	156	CURR. CONV. 1	186	P/BAL	216	PRICE INQ
127	Numeric 8	157	CURR. CONV. 2	187	PAID OUT 1	217	CASH OUT
128	Numeric 9	158	CURR. CONV. 3	188	PAID OUT 2	218	KBD SHIFT
129	Numeric 0	159	CURR. CONV. 4	189	PAID OUT 3		
130	Numeric 00	160	DRIVE THRU	190	PAPER FEED		
131	DECIMAL	161	EAT IN	191	PRINT CHECK		
132	#/NS	162	ERR CORRECT	192	PROMO		
133	%1	163	F/S SHIFT	193	REC ON ACCT 1		
134	%2	164	F/S SUB	194	REC ON ACCT 2		
135	%3	165	F/S TEND	195	REC ON ACCT 3		
136	%4	166	GUEST	196	SUBTOTAL		
137	%5	167	PLU	197	SCALE		
138	X/TIME	168	PRICE LEVEL 1	198	SERVICE		
139	ADD CHECK	169	PRICE LEVEL 2	199	TABLE #		
140	CANCEL	170	MACRO 1	200	TARE		
141	CASH	171	MACRO 2	201	TAKE OUT		
142	CHARGE 1	172	MACRO 3	202	TAX EXEMPT		
143	CHARGE 2	173	MACRO 4	203	TAX SHIFT 1		
144	CHARGE 3	174	MACRO 5	204	TAX SHIFT 2		
145	CHARGE 4	175	MACRO 6	205	TAX SHIFT 3		
146	CHARGE 5	176	MACRO 7	206	TAX SHIFT 4		



## RS232C Port 1/RS232C Port 2 Options

Turn the control lock to the **S** position

To program PORT1 enter **80** and press **SBTL** key.

To program PORT2 enter **81** and press **SBTL** key.

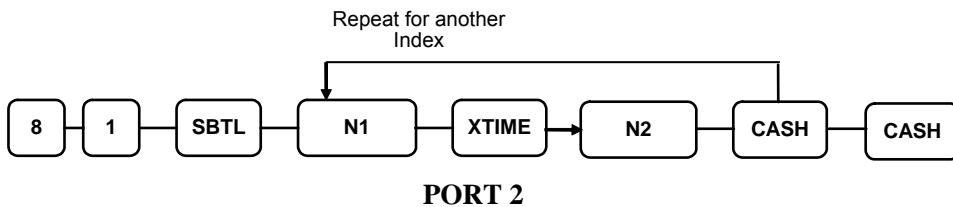
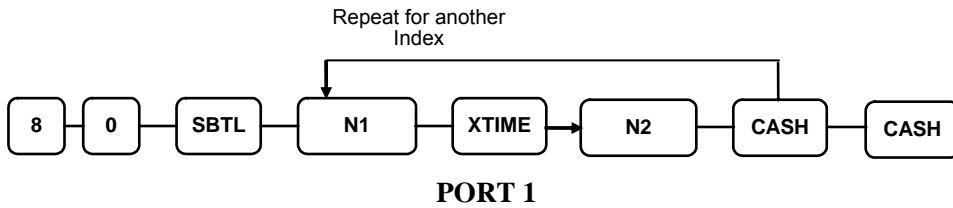

N1	OPTION	N2	VALUE
1	Baud Rate	0	9600 BPS
		1	1200 BPS
		2	2400 BPS
		3	4800 BPS
		4	19200 BPS
2	Parity	0	NONE
		1	ODD
		2	EVEN
3	Data Bits	0	8 BITS
		1	7 BITS
4	Stop Bits	0	1 BIT
		1	2 BIT
5	Device Function	0	NONE
		1	PC
		2	SCALE
		3	RJ
		4	RECEIPT PRINTER
		6	SCANNER
		7	COIN

<b>N1</b>	<b>OPTION</b>	<b>N2</b>	<b>VALUE</b>
		8	EFT
		9	POLE
<b>6</b>	Initial Feeding Line KP	0 - 20	
<b>7</b>	End Feeding Line KP	0 - 20	
<b>8</b>	Initial Feeding Line Slip	0 - 20	
<b>9</b>	Print Line On Guest Check	0 - 50	
<b>10</b>	Scale Type	0	NCI
		1	CAS
<b>11</b>	Printer Type	0	NONE
		1	SAM4S ELLIX10
		2	SAM4S ELLIX20
		3	SRP-270
		4	SRP-300/350
		5	CITIZEN3550
		6	CITIZEN810
		7	CITIZEN230
		8	EPSON TMT88-2
		9	EPSON U200
		10	EPSON U295
		11	EPSON U300
		12	EPSON U325
		13	EPSON U375
		14	STAR SP-200
		15	STAR SP-298
		16	STAR SP-300
17	STAR TSP-200		
<b>12</b>	Pole Display	0	EPSON
		1	ICD
<b>13</b>	EFT TYPE	0	EFT GLED
		1	EFT INGE
		2	EFT ZVT700
		3	TYRO EFTPOS
<b>14</b>	EFT CONFIG BYTE	0 - 127	
<b>15</b>	EFT CURRENCY	0	NONE
		1	DM
		2	EURO
<b>16</b>	EFT PASSWORD	0- 99999999	

# Program Mode Programming

---

## Default Programming

All keyboard PLUs are taxable and open, without entry limits by default status programming of "40000000".

- All system options are set to **0** in default programming, unless otherwise noted. Change only the options, which will deviate, from default programming. There is no need to re-enter an option status of **0**, since **0** is its original setting.
- All programming (unless otherwise stated) is done with the control lock in the **P** position. Each section details a specific area of register programming.
- The default settings apply to GOD v1.8 and later.

---

## Descriptor Programming Methods

Descriptors are programmable for PLUs, function keys, groups, clerks and the logo/messages. There is a method available to program descriptors the *Descriptor Code Method*.

## Program Overlay Method

### *ER420M Alpha Keyboard Overlay*

		J	L
C	F	I	
B	E	H	K
A	D	G	

7	8	9
4	5	6
1	2	3
0	00	.

P	T	X	Z	SPACE
O	S	W	Y	DOUBLE
N	R	V		CAPS
M	Q	U		

## Descriptor Code

### Descriptor Code Chart

CHAR	Ç	ü	é	â	ä	à	á	ç	ê	ë
CODE	001	002	003	004	005	006	007	008	009	010
CHAR	è	ï	î	ì	Ä	Å	É	æ	Æ	ô
CODE	011	012	013	014	015	016	017	018	019	020
CHAR	ö	ò	û	ù	ÿ	Ö	Ü	ç	\$	¥
CODE	021	022	023	024	0250	026	027	028	029	030
CHAR	€	SPACE	!	"	#	\$	%	&	'	(
CODE	031	032	033	034	035	036	037	038	039	040
CHAR	)	*	+	,	-	.	/	0	1	2
CODE	041	042	043	044	045	046	047	048	049	050
CHAR	3	4	5	6	7	8	9	:	;	<
CODE	051	052	053	054	055	056	057	058	059	060
CHAR	=	>	?	@	A	B	C	D	E	F
CODE	061	062	063	064	065	066	067	068	069	070
CHAR	G	H	I	J	K	L	M	N	O	P
CODE	071	072	073	074	075	076	077	078	079	080
CHAR	Q	R	S	T	U	V	W	X	Y	Z
CODE	081	082	083	084	085	086	087	088	089	090
CHAR							a	b	c	d
CODE	091	092	093	094	095	096	097	098	099	100
CHAR	e	f	g	h	i	j	k	l	m	n
CODE	101	102	103	104	105	106	107	108	109	110
CHAR	o	p	q	r	s	t	u	v	w	x
CODE	111	112	113	114	115	116	117	118	119	120
CHAR	y	z	BACK SPACE			Double				
CODE	121	122	123			999				

---

## Tax Programming

The *ER-420M* has the capability to support four separate taxes.

Taxes can be calculated as either a straight percentage rate of between .001% and 99.999%, or a 60 break point tax table. Each tax may be either an add-on tax (added to the cost of a taxable item), or a value added tax (VAT) that is included in the price of the item.

Tax rate 4 may be set to function as the Canadian Goods & Services Tax (GST). Definitions for tax rates 1, 2, 3 & 4 are made as part of tax programming.

- Australian GST is the default setting.
- If you are entering a tax rate (add-on or VAT), see "Straight Percentage Tax Rate Programming" to enter the percentage rate.
- If you are entering a Canadian Goods and Services Tax (GST), use tax rate 4 for the GST tax, and use tax rates 1, 2 and/or 3 for any other provincial tax or taxes. See "Straight Percentage Tax Rate Programming" to enter the GST status and percentage rate.

---

Important Note: After you have entered your tax program(s), test for accuracy by entering several transactions of different amounts. Carefully check to make sure the tax charged by the cash register matches the tax on the printed tax chart for your area. As a merchant, you are responsible for accurate tax collection. If the cash register is not calculating tax accurately, contact your dealer for assistance.

---

### ***Descriptor***

- Refer to "Program 80 – Function Key Descriptor"

## **Straight Percentage Tax Rate Programming**

When tax requirements may be met using a straight percentage rate, use the following method to program a tax as a straight percentage.

### ***Programming Straight Percentage Tax Rates and Status***

1. Turn the control lock to the **P** position.
2. If the tax is a percentage rate, with a decimal (0.000-99.999), it is not necessary to enter preceding zeros. For example, for 6%, enter 06.000 or 6.000.
3. For the type of tax:

If the tax is a percentage added to the sale (normal add on tax), enter:	<b>0</b>
If the tax is a percentage value added tax (VAT; calculated as part of the sale), enter:	<b>2</b>

- Enter **0** here for all taxes, unless you are programming tax 4 as a Canadian GST. If tax 4 is a Canadian GST, enter the sum of the options below:

OPTION	VALUE	=	SUM
GST (tax 4) is taxable by rate 1?	Yes = 1 No = 0		
GST (tax 4) is taxable by rate 2?	Yes = 2 No = 0		
GST (tax 4) is taxable by rate 3?	Yes = 4 No = 0		

- Press the Tax Shift key for the tax you are programming.
- Press the **CASH** key to end programming.

### ***Tax Rate Programming Flowchart***

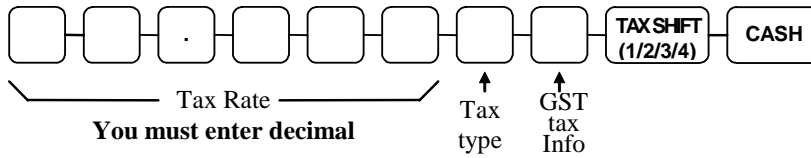

---

## PLU Programming

All PLUs, whether they are registered by pressing a PLU key on the keyboard, or by entering the PLU number and pressing the **PLU** key, have the same programming options. These options are set through separate programs:

- Program 100 – PLU Status Programming determines whether the PLU is open, preset or inactive. Also selected here are tax, food stamp, scale, negative, single item, hash, gallonage, compulsory number entry, compulsory validation, compulsory condiment and print options.
- Program 110 – PLU Auto tare Programming
- Program 150 – PLU Group Assignment allows you to select up to two groups where each PLUs sale will accumulate.
- Program 200 - PLU Price/HALO Programming determines the PLU price if the PLU is preset, or the high amount lock out (HALO) if the PLU is open.
- Program 250 - PLU Stock Amount Programming and ADD STOCK function key.
- Program 300 - PLU Description Programming allows you to set a unique, up to 18 character, descriptor for each PLU.
- Program 350 - PLU Link Programming allow you to link a PLU to another PLU, so that registration of the first PLU will automatically trigger registration of the linked PLU.
- Program 400 - PLU Delete Programming allows you to delete the PLU.
- Program 450 - PLU Mix & Match Programming.



## Program 100 - PLU Status Programming

1. Turn the control lock to the **P** position.
2. To begin the program, enter **1 0 0**, press the **SBTL** key.

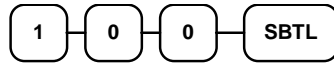

3. Select the PLU or PLUs you wish to program in one of the following ways:

- Press a PLU key on the keyboard, or



- Press the first PLU keys that are to receive the same status and Press the last PLU keys, or



- Enter up to 15 digit number of the PLU and press the **PLU** key, or

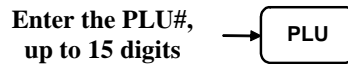

- Enter the number of the first PLU in a range of PLUs that are to receive the same setting; press the **PLU** key. Enter the last number in the range; press the **PLU** key.

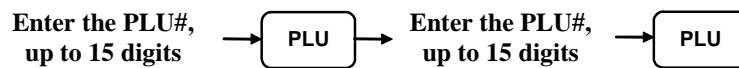

4. Refer to the "PLU Status Chart" to determine the values for **N1** through **N9**. (If an address offers more than one option, add the values for each option and enter the sum. For example, if you wish the PLU to be taxable by rates 1 and 3, add the values for your choices, 1 + 4, and enter the sum "5" for address N5.) Enter the values you have selected, press the **X/TIME** key. (You do not need to enter preceeding zeros. For example, if you are only selecting a value for N8, i.e. print price on guest check number 1, just enter 10.) Australian GST status is preset by default.



5. To program additional PLUs, repeat from step 3, or press the **CASH** key to finalise the program.



### PLU Status Chart

Address	Program Option	Value	=	Sum
<b>N1</b>	PLU is preset?	Yes = 0 No = 1		
	PLU is override preset ?	Yes = 0 No = 2		
	PLU is taxable by rate 1?	Yes = 4 No = 0		
<b>N2</b>	PLU is taxable by rate 2?	Yes = 1 No = 0		
	PLU is taxable by rate 3?	Yes = 2 No = 0		
	PLU is taxable by rate 4?	Yes = 4 No = 0		
<b>N3</b>	PLU is food stamp eligible?	Yes = 1 No = 0		
	PLU is negative item?	Yes = 2 No = 0		
	PLU is hash?	Yes = 4 No = 0		
<b>N4</b>	PLU is single item?	Yes = 1 No = 0		
	Compulsory non-add number?	Yes = 2 No = 0		
	PLU is gallonage?	Yes = 4 No = 0		
<b>N5</b>	PLU is inventory?	Yes = 1 No = 0		
	PLU is inactive?	Yes = 2 No = 0		
	PLU is scalable?	Yes = 4 No = 0		
<b>N6</b>	PLU is auto-scale entry?	Yes = 1 No = 0		
	PLU is a condiment?	Yes = 2 No = 0		
	Compulsory condiment entry?	Yes = 4 No = 0		
<b>N7</b>	Print PLU on receipt?	Yes = 0 No = 1		
	Print PLU on detail?	Yes = 0 No = 2		
	Print PLU on check?	Yes = 0 No = 4		
<b>N8</b>	Print item's price on receipt?	Yes = 0 No = 1		
	Print item's price on check?	Yes = 0 No = 2		
	PLU is disabled PROMO function?	Yes = 4 No = 0		

<b>Address</b>	<b>Program Option</b>	<b>Value</b>	<b>=</b>	<b>Sum</b>
<b>N9</b>	PLU counter is not reset when a PLU Z report is done?	Yes = 1 No = 0		
	PLU is preset override in MGR control?	Yes = 2 No = 0		

## Program 110 - PLU Auto Tare Programming

1. Turn the control lock to the **P** position.
2. To begin the program, enter **1 1 0**, press the **SBTL** key

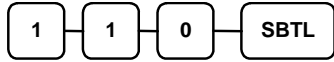

3. Select the PLU or PLUs you wish to program in one of the following ways:

Press on the keyboard, or



Press the first PLU keys that are to receive the same status and Press the last PLU keys, or



Enter up to 15 digit number of the PLU and press the **PLU** key, or

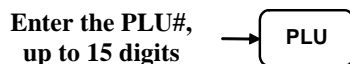

Enter the number of the first PLU in a range of PLUs that are to receive the same setting; press the **PLU** key. Enter the last number in the range; press the **PLU** key.

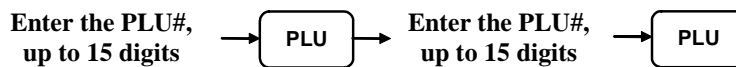

4. Enter a value(1-5) to indicate the number of the preprogrammed tare weight you want to automatically subtract when the PLU is used for scale entry (using an optional scale). Enter 0 to disable automatic tare subtraction.

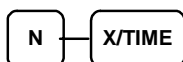

5. program additional PLUs, repeat from step 3, or press the **CASH** key to finalize the program.



## Program 150 - PLU Group Assignment

Each PLU may report to any three levels of groups. Group totals appear on reports, so that you can track sales of different types of items. A group can also be used to designate items that are to print on an optional kitchen printer.

---

Note: The PLU will report to group "0", if not programmed to report to groups 1-20.

---

1. Turn the control lock to the **P** position.
2. To begin the program, enter **1 5 0**, press the **SBTL** key.

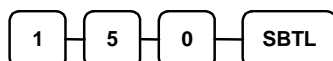

3. Select the PLU or PLUs you wish to program in one of the following ways:

- Press a PLU key on the keyboard, or

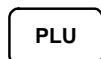

- Press the first PLU keys that are to receive the same status and Press the last PLU keys, or



- Enter up to 15 digit number of the PLU and press the **PLU** key, or

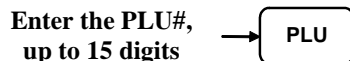

- Enter the number of the first PLU in a range of PLUs that are to receive the same setting; press the **PLU** key. Enter the last number in the range; press the **PLU** key.

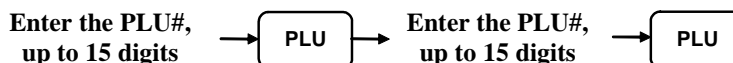

4. Enter up to three 2-digit numbers representing the groups where you wish to add the PLUs sales, i.e. enter **1 0** for group 10 or enter **0 4** for group four. Press the **X/TIME** key.

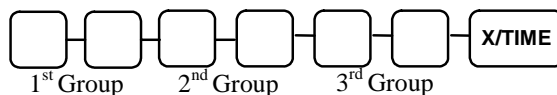

5. To program additional PLUs, repeat from step 3, or press the **CASH** key to finalise the program.



## Program 200 - PLU Price/HALO Programming

If a PLU is open, set the HALO (high amount lock out) here. If a PLU is preset set the preset price here. If a PLU is set with gallonage status, enter the price per gallon here. (Enter price per gallon in tenths of a penny, i.e. 1299 for \$1.29 9/10 per gallon.)

1. Turn the control lock to the **P** position.
2. To begin the program, enter **2 0 0**, press the **SBTL** key.



3. Select the PLU or PLUs you wish to program in one of the following ways:

- Press a PLU key on the keyboard, or

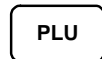

- Press the first PLU keys that are to receive the same status and press the last PLU keys, or



- Enter up to 15 digit number of the PLU and press the **PLU** key, or

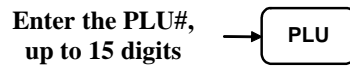

- Enter the number of the first PLU in a range of PLUs that are to receive the same setting; press the **PLU** key. Enter the last number in the range; press the **PLU** key.

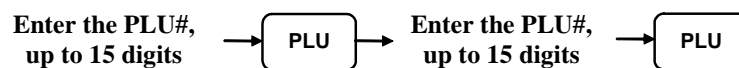

4. If the PLU is open, enter a HALO of up to 7 digits. If the PLU is preset, enter a preset price.



If the PLU Price Level is 2, Repeat this again.



5. To program additional PLUs, repeat from step 3, or press the **CASH** key to finalise the program.



## Program 250 - PLU Stock Amount Programming

With this program, you can add stock to the PLU sales counters for PLUs you have designated as stock keeping PLUs.

1. Turn the control lock to the **P** position.
2. To begin the program, enter **2 5 0**, press the **SBTL** key.

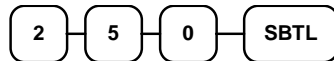

3. Select the PLU or PLUs you wish to program in one of the following ways:

- Press a PLU key on the keyboard, or



- Press the first PLU keys that are to receive the same status and Press the last PLU keys, or



- Enter up to 15 digit number of the PLU and press the **PLU** key, or

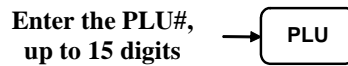

- Enter the number of the first PLU in a range of PLUs that are to receive the same setting; press the **PLU** key. Enter the last number in the range; press the **PLU** key.

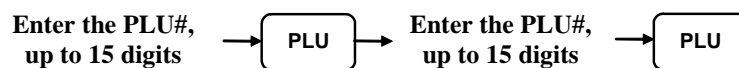

4. Enter the stock amount you wish to add (up to six digits), press the **X/TIME** key.



Stock Amount

5. To program additional PLUs, repeat from step 3, or press the **CASH** key to finalize the program.



## Program 300 - PLU Description Programming

---

Program descriptors by typing descriptors on the alpha keyboard overlay or by entering three digit alpha character codes. To describe by three digit alpha character codes you must select 'No' in system option #25(See "System Option Programming").

---

1. Turn the control lock to the **P** position
2. To begin the program, enter **3 0 0**, press the **SBTL** key.

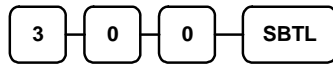

3. Select the PLU you wish to program in one of the following ways:

- Press a PLU key on the keyboard, or

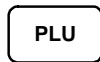

- Enter up to 15 digit number of the PLU and press the **PLU** key, or

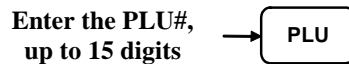

4. If you are programming using alpha overlay;

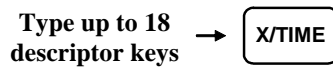

or,

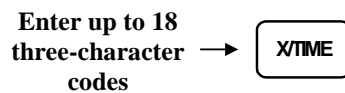

5. To program additional PLUs, repeat from step 3, or press the **CASH** key to finalise the program.





## Program 350 - PLU Link Programming

PLU link programming allows you to link a PLU to another PLU, so that registration of the first PLU will automatically trigger registration of the linked PLU. For example, you may wish to link a bottle deposit with the sale of beverages, or you may wish to register a group of items normally sold together.

1. Turn the control lock to the **P** position.
2. To begin the program, enter **3 5 0**, press the **SBTL** key.



3. Select the PLU you wish to program in one of the following ways:

- Press a PLU key on the keyboard, or



- Enter up to 15 digit number of the PLU and press the **PLU** key, or

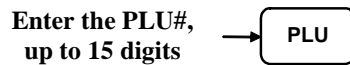

4. Enter the number of the PLU you wish the PLU linked to; press the PLU key. Or press the PLU key on the keyboard you wish the PLU linked to.

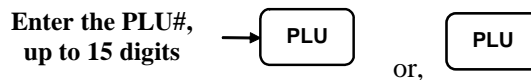

If you want to unlink,



5. To program additional PLUs, repeat from step 3, or press the **CASH** key to finalise the program.

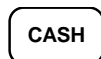

## Program 400 – PLU Delete Programming

NOTE: To delete a PLU, all totals for the PLU must be cleared from Z reports(including Stock and PLU reports.)

1. Turn the control lock to the **P** position.
2. To begin the program, enter **4 0 0**, press the **SBTL** key.

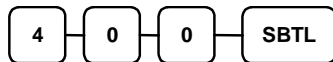

3. Select the PLU or PLUs you wish to program in one of the following ways:

- Press a PLU key on the keyboard, or

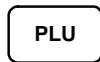

- Press the first PLU key to be deleted, then press the last PLU key to be deleted, or



- Enter up to 15 digit number of the PLU and press the **PLU** key, or

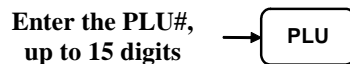

- Enter the number of the first PLU in a range to be deleted and press the **PLU** key, then enter the last number in the range, and press the **PLU** key.

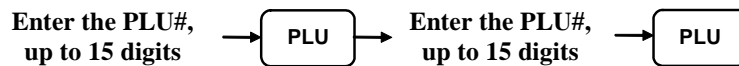

4. Press X/TIME key.

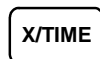

5. To program additional PLUs, repeat from step 3, or press the **CASH** key to finalise the program.



## Program 450 - PLU MIX & MATCH Programming

1. Turn the control lock to the **P** position.
2. To begin the program, enter **4 5 0**, press the **SBTL** key.



3. Select the PLU you wish to be linked to the mix & match table:

- Press a PLU key on the keyboard, or

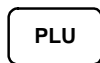

- Press the first PLU to be linked, then the PLU key, and the last PLU in the range, or



- Enter up to 15 digit number of the PLU and press the **PLU** key, or

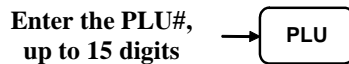

- Enter the number of the first PLU in the range, and press the PLU key, then enter the last PLU number in the range and press the PLU key.

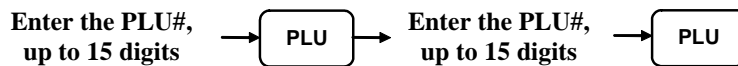

4. Enter the number of the Mix & Match Table then press the **X/TIME** key.

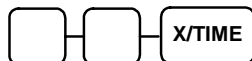

5. To program additional PLUs, repeat from step 3, or press the **CASH** key to finalise the program.



---

# System Option Programming

Refer to the “System Option Table” to review the system options. Read each option carefully to determine if you wish to make any changes.

---

**NOTE:** Because after clearing memory all options settings are automatically set to 0, and because your most likely option selections require a status setting of 0, you do not need to program this section unless you wish to change the default status.

---

## ***Programming a System Option:***

1. Turn the control lock to the **P** position.
2. Enter **3 0**, press the **SBTL** key.
3. Enter a system option address, press the **X/TIME** key.
4. Enter the number representing the status you have selected, or if there is more than one decision to be made in an address, add the values representing your choices for each decision and enter the sum. Press the **SBTL** key.
5. Repeat from step 3 for each system option you wish to change.
6. Press the **CASH** key to end system option programming.

## ***System Option Flowchart***

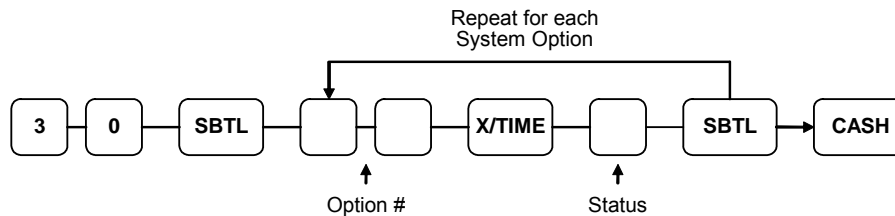

## System Option Table

Address	SYSTEM OPTION	VALUE	=	SUM
1	Beeper is active?	Yes = 0 No = 1		
2	Clerk sign on method is:	direct entry =	0	
		code entry =	1	
3	Clerks are:	pop-up =	1	
		stay down =	0	
4	Drawer needs to be shut to operate?	Yes = 0 No = 1		
	Activate open Drawer Alarm?	Yes = 2 No = 0		
5	The number of seconds before the open drawer warning tone sounds (1 - 99).	30		
6	Allow the post tender function?	Yes = 1 No = 0		
	Open drawer on post tender?	Yes = 0 No = 2		
	Allow multiple receipts?	Yes = 4 No = 0		
7	Cash Declaration Required before Z Financial report?	Yes = 1 No = 0		
	Allow negative balance sales in the X control lock position only?	Yes = 2 No = 0		
8	Allow zero balance sales in the X control lock position only?	Yes = 1 No = 0		
	Consecutive number is reset after a financial report?	Yes = 2 No = 0		
9	Reset Grand Total after Z financial Report?	Yes = 1 No = 0		
	Cash drawer will open when reports are run?	Yes = 0 No = 2		
	Open drawer during training mode?	Yes = 0 No = 4		
10	Decimal place : (0,1,2,3)	Default=2		
11	Date format is:	MMDDYY =	0	
		DDMMYY =	1(default)	
		YYMMDD =	2	
12	Percentage and Tax calculations will:	round up at 0.005 =	0(default)	
		always round up =	1	
		always round down =	2	

Address	SYSTEM OPTION		VALUE	=	SUM
13	Split price calculations will:	round up at 0.005 =	<b>0(default)</b>		
		always round up =	1		
		always round down =	2		
14	Compulsory Eat in T-out D-thru before tendering?		Yes = 1 No = 0		
	Hash is	<b>normal</b> =	<b>Yes = 0</b>		
		non-add =	No = 2		
15	Reset the Financial report Z counter after a Z1 Financial report?		Yes = 1 No = 0		
	Reset the Time report Z counter after a Z1 Time report?		Yes = 2 No = 0		
	Reset the PLU report Z counter after a Z1 PLU report?		Yes = 4 No = 0		
16	Reset the Clerk report Z counter after a Z1 Clerk report?		Yes = 1 No = 0		
	Reset the Group report Z counter after a Z1 Group report?		Yes = 2 No = 0		
17	Reset the Daily sale report Z counter after a Z2 Daily sale report?		Yes = 1 No = 0		
	Paper sensor is enabled?		<b>Yes = 0</b> No = 2		
	Deactivate Split Pricing?		Yes = 4 No = 0		
18	Allow Direct Multiply?		Yes = 1 No = 0		
	Inventory (stock) counter programming	added to current level =	Yes = 2		
		<b>counter replaces current level =</b>	<b>No = 0</b>		
19	The number of numeric digits: 0 is no limit		0-14		

Address	SYSTEM OPTION	VALUE	=	SUM
20	Direct multiply more than one digit?	Yes = 1 No = 0		
	Tender Validation amount is:	amount tendered = amount of sale =	Yes = 2 No = 0	
21	Display add price of linked item?	Yes = 1 No = 0		
	Allow sale when stock reaches "0"?	Yes = 0 No = 2		
	Allow Australian round on subtotal?	Yes = 4 No = 0		
22	Allow Australian round on cash?	Yes = 1 No = 0		
	Allow Z stock report?	Yes = 0 No = 2		
23	Training mode	enter =	1	
		exit =	0	
24	Not Used			
25	Descriptor pgm Method	Keyboard overlay=	0	
		Character code =	1	
	% is not affect to net sale?		Yes = 2 No = 0	
	Disable Cash Declaration?		Yes = 4 No = 0	
26	Table Management =	0		
	Clerk Interrupt =	1		
27	Disable level keys:	Level1 =	Yes = 1 No = 0	
		Level2 =	Yes = 2 No = 0	
28	Price level is:	Pop-up after item =	0	
		Pop-up after sale =	1	
		Stay-down =	2	
29	Modifier is:	Pop-up after item =	0	
		Pop-up after sale =	1	
		Stay-down =	2	
30	Embedded price barcode type (call Goodson) (1/2/3/4/7)	0		
31	Rset GST after service on hard check?	Yes = 1 No = 0		
32	Allow New Zealand round on subtotal? (must turn AU off first)	Yes = 1 No = 0		

Address	SYSTEM OPTION	VALUE	=	SUM
	Allow New Zealand round on cash? (must turn AU off first)	Yes = 2 No = 0		



---

## Print Option Programming

Refer to the “Print Option Table” to review the print options. Read each option carefully to determine if you wish to make any changes.

---

**NOTE:** Because after clearing memory all options settings are automatically set to 0, and because your most likely option selections require a status setting of 0, you do not need to program this section unless you wish to change the default status.

---

### ***Programming a Print Option:***

1. Turn the control lock to the **P** position.
2. Enter **4 0**, press the **SBTL** key.
3. Enter a print option address, press the **X/TIME** key.
4. Enter the number representing the status you have selected, or if there is more than one decision to be made in an address, add the values representing your choices for each decision and enter the sum. Press the **SBTL** key.
5. Repeat from step 3 for each print option you wish to change.
6. Press the **CASH** key to end print option programming.

### ***Print Option Flowchart***

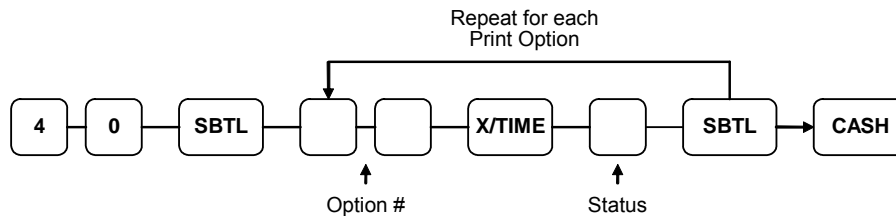

## Print Option Table

Address	PRINT OPTION	VALUE	=	SUM
1	Print media total on clerk report?	Yes = 1 No = 0		
	Print tax symbol?	Yes = 0 No = 2		
2	Void/Return totals will print on the Financial report?	Yes = 0 No = 1		
	Audaction total will print on the Financial report?	Yes = 2 No = 0		
3	Skip media totals with zero activity on the Financial report?	Yes = 0 No = 1		
	Skip media totals with zero activity on the Clerk report?	Yes = 0 No = 2		
	Print Clerk report at the end of the Financial report?	Yes = 4 No = 0		
4	Print PLU sale item number?	Yes = 1 No = 0		
	Print PLU with zero totals on report?	Yes = 2 No = 0		
	Subtotal is printed when the SBTL key is pressed?	Yes = 4 No = 0		
5	Print percentage of sales on the PLU report?	Yes = 1 No = 0		
	Print consecutive number counter on receipt?	Yes = 0 No = 2		
6	Print date on receipt?	Yes = 0 No = 1		
	Print time on receipt?	Yes = 0 No = 2		
	Not used			
7	Print clerk name on receipt?	Yes = 0 No = 1		
	Print Z counter on reports?	Yes = 0 No = 2		
8	Home Currency symbol	\$ (default)		
9	Print receipt when sign on/off?	Yes = 0 No = 1		
	Print Grand total on the X Financial report?	Yes = 0 No = 2		
	Print Grand total on the Z Financial report?	Yes = 0 No = 4		
10	Print Gross total on the X Financial report?	Yes = 0 No = 1		
	Print Gross total on the Z Financial report?	Yes = 0 No = 2		

Address	PRINT OPTION		VALUE	=	SUM
11	Print the subtotal without tax on the receipt?		Yes = 1 No = 0		
	Tax amount to print on receipt is:	combine =	Yes = 2		
		itemize =	No = 0		
12	Print the tax amount on receipt?		Yes = 0 No = 1		
	Print taxable totals?		Yes = 2 No = 0		
	Print the tax rate?		Yes = 4 No = 0		
13	Print a breakdown of the VAT eligible sale?		Yes = 1 No = 0		
	Print training mode message on the receipt during training mode operations?		Yes = 2 No = 0		
14	Currency Symbol: (see note2 below)	CONV. #1 =	.		
15		CONV. #2 =	.		
16		CONV. #3 =	.		
17		CONV. #4 =	.		
18	Print the <i>kitchen printer</i> order number on the Receipt?		Yes = 0 No = 1		
	Print the item's price on the kitchen printer requisition?		Yes = 2 No = 0		
19	Print registrations in void mode on the kitchen printer / KP requisition?		Yes = 0 No = 1		
	Print registrations in training mode on the kitchen printer/ KP requisition?		Yes = 2 No = 0		
	Print round amount on the kitchen printer/KP requisition?		Yes = 4 No = 0		
20	Combine like items on the kitchen printer?		Yes = 0 No = 1		
	Consolidation of like items on check track?		Yes = 0 No = 2		
	Chooses volume unit When the PLU is gallonage.	gallons =	0		
liters =		4			
21	Print preamble message on receipt?		Yes = 0 No = 1		
	Print postamble message on receipt?		Yes = 0 No = 2		
	Print preamble message on the guest check?		Yes = 4 No = 0		
22	Print postamble message on the guest check?		Yes = 1 No = 0		

Address	PRINT OPTION	VALUE	=	SUM
	Do not print pre/postamble message on the journal receipt?	Yes = 0 No = 2		
23	Print average items per customer on the Financial report?	Yes = 0 No = 1		
	Print average sales per customer on the Financial report?	Yes = 0 No = 2		
24	Issue a second receipt for the same transaction?	Yes = 1 No = 0		
	Priority print by group on the kitchen printer?	Yes = 2 No = 0		
	Print the PLU number and descriptor on the receipt?	Yes = 4 No = 0		
25	Print when polling reports?	Yes = 1 No = 0		
	Print PLU# on PLU report?	Yes = 2 No = 0		
	Grand total is:	net sale = 4 gross sale = 0		
26	Print journal font	small = 1		
		normal = 0		
	Print journal reverse about VOID PLU ?	Yes = 2		
		No = 0		
Journal print is off?	Yes = 4 No = 0			
27	Send order to the kitchen printer when the SBTL key is pressed?	Yes = 1 No = 0		
	Print date on hard check?	Yes = 2 No = 0		
28	Pre Print graphic logo on receipt?	Yes = 1 No = 0		
	Post Print graphic logo on receipt?	Yes = 2 No = 0		
29	Pre Print graphic logo on the guest check?	Yes = 1 No = 0		
	Post Print graphic logo on the guest check?	Yes = 2 No = 0		
30	Print pre- logo	Default = 0		
		User = 1		
	Print post- logo	Default = 0		
		User = 2		
31	Number of Pre-feeding lines on Receipt (0-5)	0		
32	Number of Post-feeding lines on Receipt (0-5)	0		

---

NOTE 1: Print Option# 8 - Users outside of the USA can designate a different currency symbol. To select a different symbol, type descriptors on the alpha keyboard overlay or enter three digit alpha character codes. To describe by three digit alpha character codes you must select 'No' in system option #25(See "System Option Programming").

NOTE 2: Print Option# 14,15,16,17 - If you are using the currency conversion feature, you can select the appropriate symbol for each foreign currency you are accepting. To select a different symbol, type descriptors on the alpha keyboard overlay or enter three digit alpha character codes. To describe by three digit alpha character codes you must select 'No' in system option #25 Overlay Descriptor(See "System Option Programming").

---

---

## Function Key Programming

Three programs are used to program function keys;

- *Program 70* - is used to set each keys individual options
- *Program 80* - is used to program a 18 character alpha numeric descriptor
- *Program 90* - is used to set a high amount limit (HALO)

In this chapter you will find:

- General instructions for programs 70, 80 and 90.
- Specific programming instructions for each function key.

## Program 70 - Function Key Options

Use Program 70 to set options for function keys. Because of the differences inherent in function keys, individual options will be different. See the specific instructions for each key in this chapter to find the options for each key.

1. Turn the control lock to the **P** position.
2. To begin the program, enter **7 0**, press the **SBTL** key.

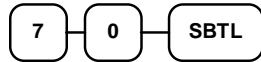

3. Enter the values for the option digit or digits. Depending on the function key you are programming, you may enter up to five digits **N1** through **N6**. Determine the values for **N1** through **N6** by referring to the specific function key information that follows. (You do not need to enter preceding zeros. For example, if the function key offers six digits, **N1** through **N6** and you are only selecting a value for **N6**, just enter the value for **N6**.) Press the function key you wish to program.

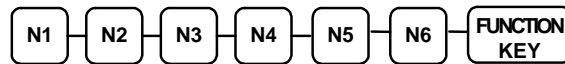

4. To program additional function keys, repeat from step 3, or press the **CASH** key to finalise the program.



## Program 80 - Function Key Descriptor

---

Program descriptors by typing descriptors on the alpha keyboard overlay or by entering three digit alpha character codes. To describe by three digit alpha character codes you must select 'No' in system option #25(See "System Option Programming").

---

1. Turn the control lock to the **P** position.
2. To begin the program, enter **8 0**, press the **SBTL** key.

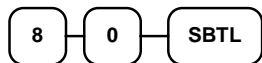

3. If you are programming alpha overlay

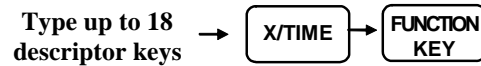

or,

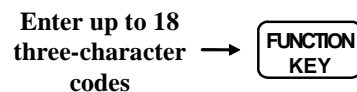

4. To program additional function keys, repeat from step 3, or press the **CASH** key to finalise the program.

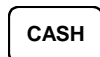



## Program 90 - Function Key HALO

Use Program 90 to program a high amount lock out (HALO) for a function key. Only specific keys require this program. For example, you can set a HALO for the **CASH**, **CHECK** or **CHARGE** keys. Refer to the specific function key programming information in this chapter to determine when the HALO option is available.

1. Turn the control lock to the **P** position.
2. To begin the program, enter **9 0**, press the **SBTL** key.

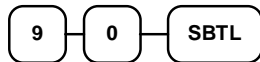

3. Enter a HALO of up to eight digits, (or "0" for no HALO).

**Enter 1-8 digit  
HALO**

4. Press the function key on the keyboard you wish to program.



5. To program additional function keys, repeat from step 2, or press the **CASH** key to finalise the program.



# ADD CHECK

## Options - Program 70

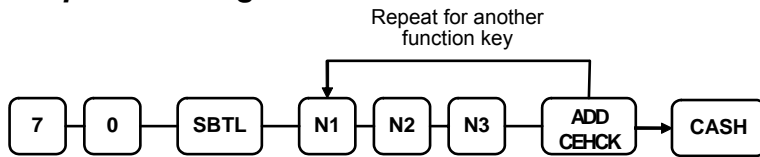

Address	OPTION	VALUE	=	SUM
<b>N1</b>	Key is inactive?	Yes = 1 No = 0		
	Compulsory before tendering?	Yes = 2 No = 0		
	Advance the consecutive # when this function is used?	Yes = 0 No = 4		
<b>N2</b>	Delete the pre/postamble when this function is used?	Yes = 0 No = 1		
	Exempt tax 1?	Yes = 2 No = 0		
	Exempt tax 2?	Yes = 4 No = 0		
<b>N3</b>	Exempt tax 3?	Yes = 1 No = 0		
	Exempt tax 4?	Yes = 2 No = 0		
	Validation is compulsory?	Yes = 4 No = 0		

### Descriptor

- Refer to "Program 80 – Function Key Descriptor"

# CANCEL

## Options - Program 70

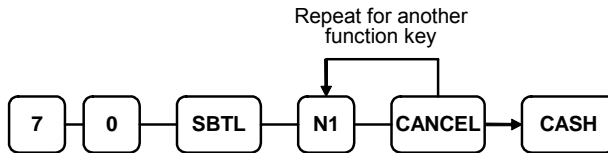

Address	OPTION	VALUE	=	SUM
N1	Key is inactive?	Yes = 1 No = 0		
	Key is active in <b>X</b> control lock position only?	Yes = 2 No = 0		
	Validation is compulsory?	Yes = 4 No = 0		

### Descriptor

- Refer to “Program 80 – Function Key Descriptor”

### HALO

- Refer to “Program 90 – Function Key HALO ”

# CASH

## Options - Program 70

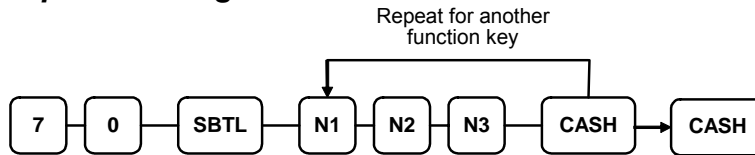

Address	OPTION	VALUE	=	SUM
<b>N1</b>	Amount tender is compulsory?	Yes = 1 No = 0		
	Allow over tendering and under tendering in X control lock position only?	Yes = 2 No = 0		
	Disable under tendering?	Yes = 4 No = 0		
<b>N2</b>	Open cash drawer?	Yes = 0 No = 1		
	Exempt tax 1?	Yes = 2 No = 0		
	Exempt tax 2?	Yes = 4 No = 0		
<b>N3</b>	Exempt tax 3?	Yes = 1 No = 0		
	Exempt tax 4?	Yes = 2 No = 0		
	Validation is compulsory?	Yes = 4 No = 0		

### Descriptor

- Refer to "Program 80 – Function Key Descriptor"

### HALO

- Refer to "Program 90 – Function Key HALO"

## CHARGE1-8

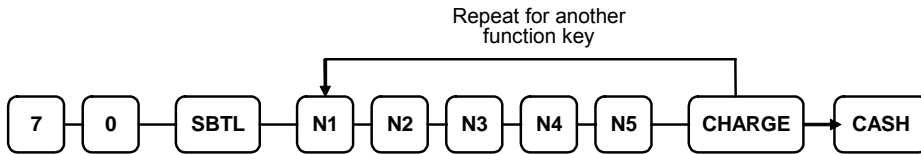

Address	OPTION	VALUE	=	SUM
<b>N1</b>	Amount tender is compulsory?	Yes = 1 No = 0		
	Allow over tendering and under tendering in <b>X</b> control lock position only?	Yes = 2 No = 0		
	Disable under tendering?	Yes = 4 No = 0		
<b>N2</b>	Open cash drawer?	Yes = 0 No = 1		
	Allow over tendering ?	Yes = 2 No = 0		
	Non-add # entry compulsory?	Yes = 4 No = 0		
<b>N3</b>	Exempt tax 1?	Yes = 1 No = 0		
	Exempt tax 2?	Yes = 2 No = 0		
	Exempt tax 3?	Yes = 4 No = 0		
<b>N4</b>	Exempt tax 4?	Yes = 1 No = 0		
	Validation compulsory?	Yes = 2 No = 0		
	Send to EFT?	Yes = 4 No = 0		
<b>N5</b>	EFT Port (0-2)	<b>0</b>		

### **Descriptor**

- Refer to “Program 80 – Function Key Descriptor”

### **HALO**

- Refer to “Program 90 – Function Key HALO”

# CHECK

## Options - Program 70

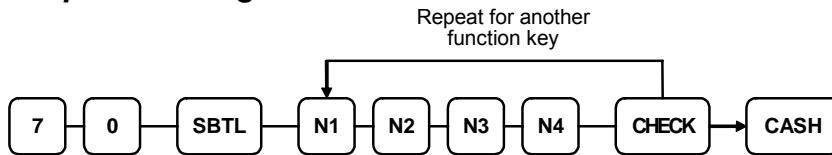

Address	OPTION	VALUE	=	SUM
N1	Amount tender is compulsory?	Yes = 1 No = 0		
	Allow over tendering and under tendering in X control lock position only?	Yes = 2 No = 0		
	Disable under tendering?	Yes = 4 No = 0		
N2	Open cash drawer?	Yes = 0 No = 1		
	Exempt tax 1?	Yes = 2 No = 0		
	Exempt tax 2?	Yes = 4 No = 0		
N3	Exempt tax 3?	Yes = 1 No = 0		
	Exempt tax 4?	Yes = 2 No = 0		
N4	Check endorsement compulsory?	Yes = 1 No = 0		
	Validation is compulsory?	Yes = 2 No = 0		

### Descriptor

- Refer to "Program 80 – Function Key Descriptor"

### HALO

- Refer to "Program 90 – Function Key HALO"

## CHECK CASHING

### Options - Program 70

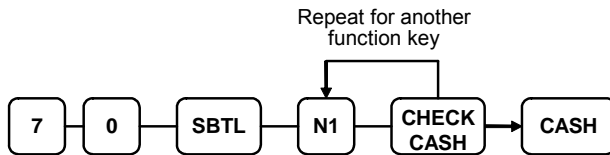

Address	OPTION	VALUE	=	SUM
N1	Key is inactive?	Yes = 1 No = 0		
	Key is active in <b>X</b> control lock position only?	Yes = 2 No = 0		
	Validation is compulsory?	Yes = 4 No = 0		

### Descriptor

- Refer to “Program 80 – Function Key Descriptor”

### HALO

- Refer to “Program 90 – Function Key HALO”

# CHECK ENDORSEMENT

## Options - Program 70

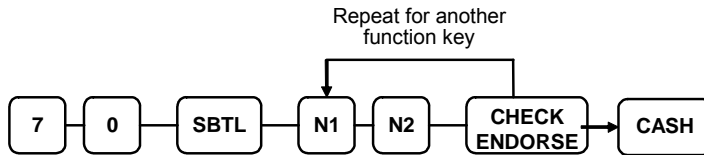

Address	OPTION	VALUE	=	SUM
<b>N1</b>	Key is inactive?	Yes = 1 No = 0		
	Print the amount of the check and endorsement message?	Yes = 2 No = 0		
	Print date?	Yes = 4 No = 0		
<b>N2</b>	Print time?	Yes = 1 No = 0		
	Print clerk?	Yes = 2 No = 0		
	Print consecutive number?	Yes = 4 No = 0		

### Descriptor

- Refer to "Program 80 – Function Key Descriptor"



## CHECK #

### Options - Program 70

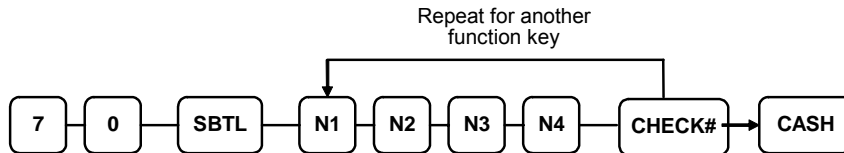

Address	OPTION	VALUE	=	SUM
<b>N1</b>	Key is inactive?	Yes = 1 No = 0		
	Required at Start of Sale?	Yes = 2 No = 0		
	Opening clerk has exclusive access?	Yes = 4 No = 0		
<b>N2</b>	Check track # and balance will print on receipt?	Yes = 0 No = 1		
	Check track # and balance will print on remote?	Yes = 0 No = 2		
	Allow only one check per table?	Yes = 4 No = 0		
<b>N3</b>	Check# is automatically assigned by register?	Yes = 1 No = 0		
	PBAL Key is used as Drive thru recall key?	Yes = 2 No = 0		
<b>N4</b>	Length of Check(0-9)	<b>0</b>		

### Descriptor

- Refer to "Program 80 – Function Key Descriptor"

## CURRENCY CONVERSION

### Currency Conversion Rate - Program 90

1. Turn the control lock to the **P** position.
2. To begin the program, enter **9 0**, press the **SBTL** key.

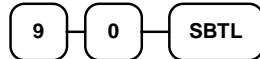

3. Enter the exchange rate of up to 7 digits (do not enter the decimal point), then enter a number from 0 to 7 to indicate the decimal position. See "Currency Exchange Rate Programming Examples" below.

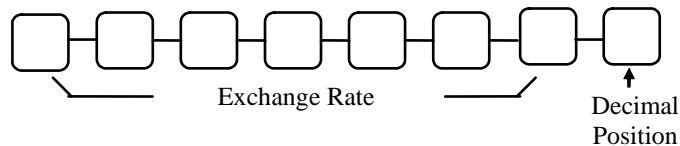

4. Press the function key on the keyboard you wish to program.



5. To program additional function keys, repeat from step 2, or press the **CASH** key to finalize the program.

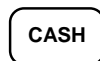

### Currency Exchange Rate Programming Examples

---

Note: Foreign currency exchange rates may be stated as "foreign currency in dollars", or "dollars in foreign currency". Use the rate stated in "dollars in foreign currency" when you are programming this section.

---

The US dollar (home currency) is worth 1.3720 Canadian dollars (foreign currency).

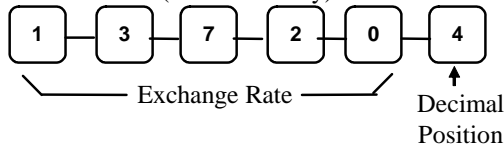

The US dollar (home currency) is worth 110.24 Japanese Yen (foreign currency).

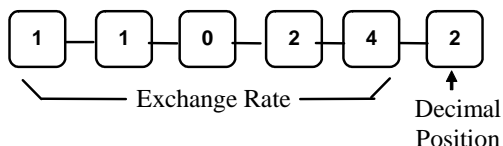

# DRIVE THRU / EAT IN / TAKE OUT

## Options - Program 70

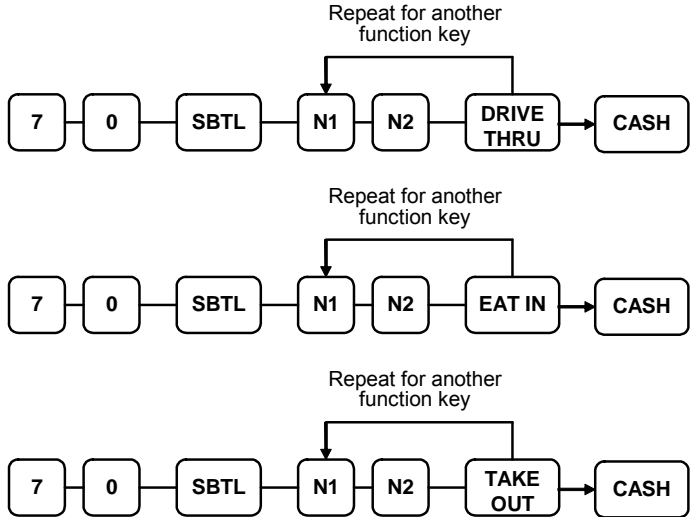

Address	OPTION	VALUE	=	SUM
N1	Exempt tax 1?	Yes = 1 No = 0		
	Exempt tax 2?	Yes = 2 No = 0		
	Exempt tax 3?	Yes = 4 No = 0		
N2	Exempt tax 4?	Yes = 1 No = 0		
	Validation is compulsory?	Yes = 2 No = 0		

### Descriptor

- Refer to "Program 80 – Function Key Descriptor"

## ERROR CORRECT

### Options - Program 70

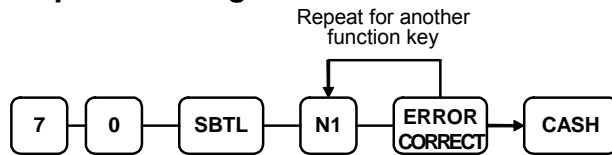

Address	OPTION	VALUE	=	SUM
N1	Key is inactive?	Yes = 1 No = 0		
	Key is active in X control lock position only?	Yes = 2 No = 0		
	Validation is compulsory?	Yes = 4 No = 0		

### Descriptor

- Refer to “Program 80 – Function Key Descriptor”

### HALO

- Refer to “Program 90 – Function Key HALO”

## F/S SUB

### Options - Program 70

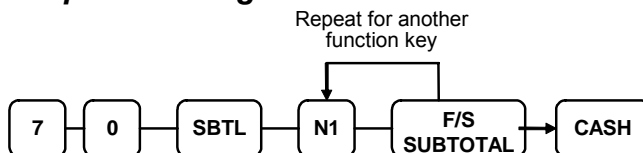

Address	OPTION	VALUE	=	SUM
N1	Key is inactive?	Yes = 1 No = 0		

### Descriptor

- Refer to “Program 80 – Function Key Descriptor”

## F/S TEND

### Options - Program 70

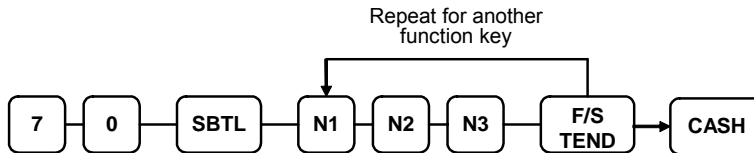

Address	OPTION	VALUE	=	SUM
<b>N1</b>	Exempt tax 1?	Yes = 1 No = 0		
	Exempt tax 2?	Yes = 2 No = 0		
	Exempt tax 3?	Yes = 4 No = 0		
<b>N2</b>	Exempt tax 4?	Yes = 1 No = 0		
	The tender is allowed in any amount?	Yes = 2 No = 0		
	Food stamp change is issued in	Cash = 4 Food stamps = 0		
<b>N3</b>	Open cash drawer?	Yes = 0 No = 1		
	Validation is compulsory?	Yes = 2 No = 0		

### Descriptor

- Refer to "Program 80 – Function Key Descriptor"

### HALO

- Refer to "Program 90 – Function Key HALO"

## GUEST

### Options - Program 70

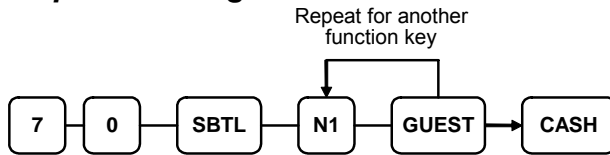

Address	OPTION	VALUE	=	SUM
N1	Required when opening a new check?	Yes = 1 No = 0		
	Before registering, enter a guest number?	Yes = 2 No = 0		
	Print Guest # at the kitchen printer?	Yes = 4 No = 0		

### Descriptor

- Refer to "Program 80 – Function Key Descriptor"

## Price LEVEL1-2

### Options - Program 70

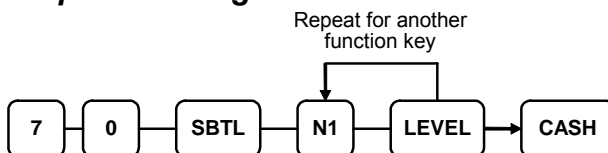

Address	OPTION	VALUE	=	SUM
N1	Print level description at the KP?	Yes = 1 No = 0		

### Descriptor

- Refer to "Program 80 – Function Key Descriptor"

## #/NS

### Options - Program 70

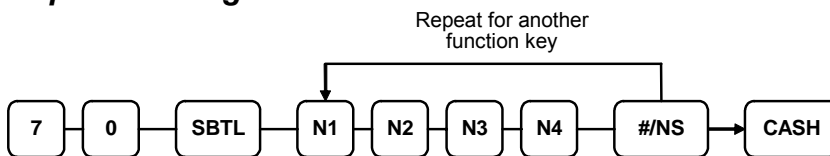

Address	OPTION	VALUE	=	SUM
<b>N1</b>	No Sale is inactive?	Yes = 1 No = 0		
	No Sale active in <b>X</b> control lock position only?	Yes = 2 No = 0		
	No Sale inactive after non-add # entry?	Yes = 4 No = 0		
<b>N2</b>	Enforce non-add # entry at start of sale?	Yes = 1 No = 0		
	Print when a NO SALE is performed?	Yes = 0 No = 2		
	Non-add # entries are prohibited?.	Yes = 4 No = 0		
<b>N3</b>	Compulsory non-add entry must match number of digits set in the MAX DIGIT flag below?	Yes = 1 No = 0		
	Print non-add on guest check?	Yes = 2 No = 0		
<b>N4</b>	Enter maximum number of digits for non-add number entry. Zero(0) means no limit. (0-8)	<b>0</b>		

### Descriptor - Programs 80 & 81

Since two distinct functions, # entry and no sale, reside on the same key, different programs are used to program each descriptor. To program the no sale descriptor:

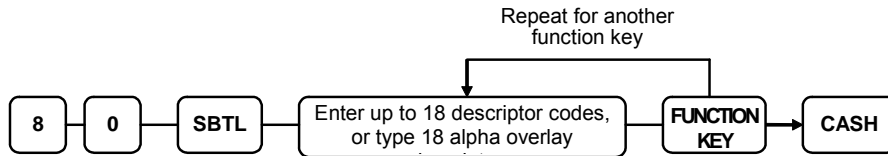

To program the # descriptor

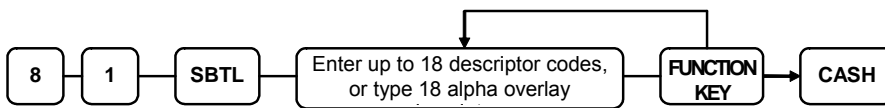

## RETURN

### Options - Program 70

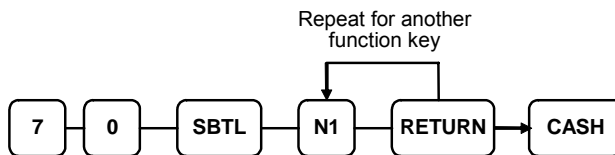

Address	OPTION	VALUE	=	SUM
N1	Key is inactive?	Yes = 1 No = 0		
	Key is active in X control lock position only?	Yes = 2 No = 0		
	Validation is compulsory?	Yes = 4 No = 0		

### Descriptor

- Refer to "Program 80 – Function Key Descriptor"

### HALO

- Refer to "Program 90 – Function Key HALO"



## MODIFIER 1-5

### Options - Program 70

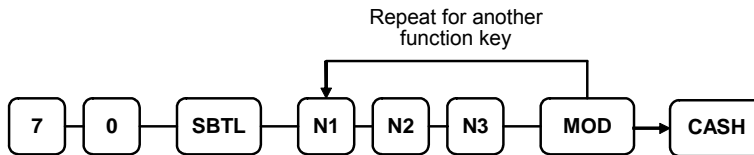

Address	OPTION	VALUE	=	SUM
N1	Key is active in X control lock position only?	Yes = 1 No = 0		
	Modify PLU#?	Yes = 2 No = 0		
N2	Print modifier descriptor on the guest check?	Yes = 1 No = 0		
	Print modifier descriptor on the receipt?	Yes = 2 No = 0		
N3	Value of affected digit(0-9)	0		

2. \* Affect Digit(1-14) of PLU#

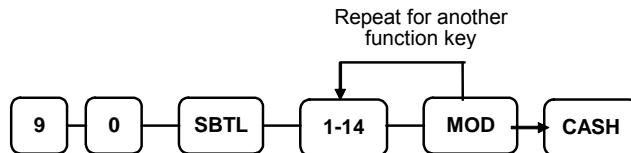

### Descriptor

- Refer to "Program 80 – Function Key Descriptor"

## PAYMENT

### Options - Program 70

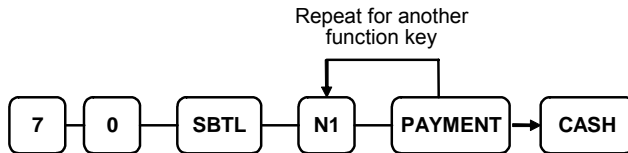

Address	OPTION	VALUE	=	SUM
N1	Require to close check?	Yes = 1 No = 0		

### Descriptor

- Refer to "Program 80 – Function Key Descriptor"

## PBAL

### Options - Program 70

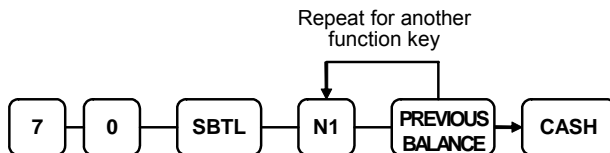

Address	OPTION	VALUE	=	SUM
N1	Previous balance may be entered at any time?	Yes = 1 No = 0		
	Previous balance required at the start of the sale?	Yes = 2 No = 0		

### Descriptor

- Refer to "Program 80 – Function Key Descriptor"

# PROMO

## Options - Program 70

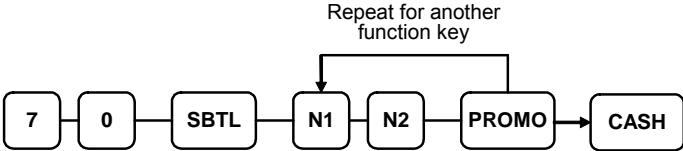

Address	OPTION	VALUE	=	SUM
N1	Key is inactive?	Yes = 1 No = 0		
	Key is active in X control lock position only?	Yes = 2 No = 0		
	Exempt tax 1?	Yes = 4 No = 0		
N2	Exempt tax 2?	Yes = 1 No = 0		
	Exempt tax 3?	Yes = 2 No = 0		
	Exempt tax 4?	Yes = 4 No = 0		

### Descriptor

- Refer to “Program 80 – Function Key Descriptor”

## PAID OUT1-3

### Options - Program 70

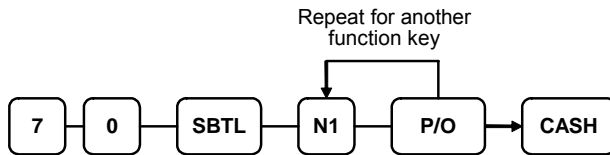

Address	OPTION	VALUE	=	SUM
N1	Key is inactive?	Yes = 1 No = 0		
	Key is active in X control lock position only	Yes = 2 No = 0		
	Validation is compulsory?	Yes = 4 No = 0		

### Descriptor

- Refer to "Program 80 – Function Key Descriptor"

# PRINT CHECK

## Options - Program 70

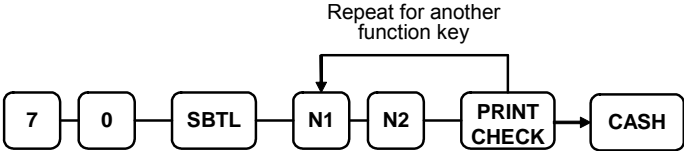

Address	OPTION	VALUE	=	SUM
N1	Enter Port Number. ( Zero if the check will print on the receipt printer)	0-2		
N2	Automatically Service Check?	Yes = 1 No = 0		
	Print Check# on Receipt	Yes = 2 No = 0		
	Skip printing consecutive # on the guest check?	Yes = 4 No = 0		

### Descriptor

- Refer to "Program 80 – Function Key Descriptor"

## RECD ON ACCT1-3

### Options - Program 70

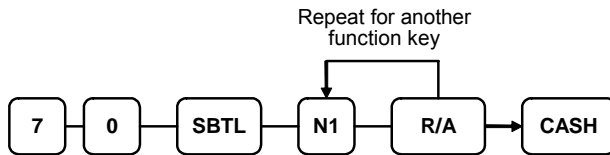

Address	OPTION	VALUE	=	SUM
N1	Key is inactive?	Yes = 1 No = 0		
	Key is active in X control lock position only?	Yes = 2 No = 0		
	Validation is compulsory?	Yes = 4 No = 0		

#### **Descriptor**

- Refer to "Program 80 – Function Key Descriptor"

#### **HALO**

- Refer to "Program 90 – Function Key HALO"

# SCALE

## Options - Program 70

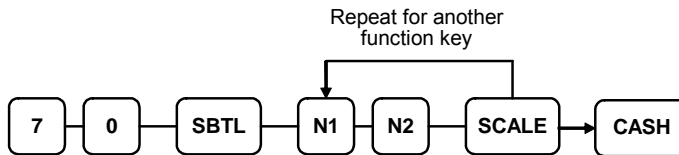

Address	OPTION	VALUE	=	SUM
<b>N1</b>	Key is inactive?	Yes = 1 No = 0		
	Key is active in <b>X</b> control lock position only?	Yes = 2 No = 0		
	Allow manual entry of weight?	Yes = 4 No = 0		
<b>N2</b>	Subtract tare weight on the scale entry?	Yes = 1 No = 0		
	Weight symbol for manual entry is:	<b>Kg</b> =	2	
		<b>Lb</b> =	0	
	Allow register scaleable items by weight extension or by price entry?	Yes = 4 No = 0		

### Descriptor

- Refer to "Program 80 – Function Key Descriptor"

## SERVICE

### Options - Program 70

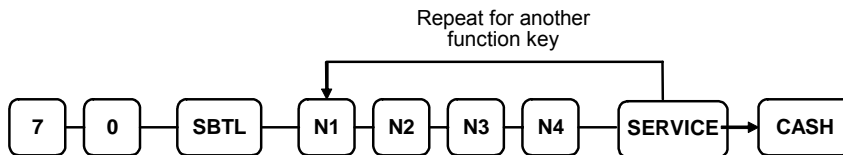

Address	OPTION	VALUE	=	SUM
<b>N1</b>	Compulsory non-add number before this key is used?	Yes = 1 No = 0		
	Print on receipt?	Yes = 0 No = 2		
	Allow negative balance in <b>X</b> control lock position only?	Yes = 4 No = 0		
<b>N2</b>	Calculate tax 1?	Yes = 0 No = 1		
	Calculate tax 2?	Yes = 0 No = 2		
	Calculate tax 3?	Yes = 0 No = 4		
<b>N3</b>	Calculate tax 4?	Yes = 0 No = 1		
	Validation is compulsory?	Yes = 2 No = 0		
<b>N4</b>	Enter the port number if you are using a hard check system (0-2).	<b>0</b>		

### Descriptor

- Refer to "Program 80 – Function Key Descriptor"



## SUBTOTAL

### Options - Program 70

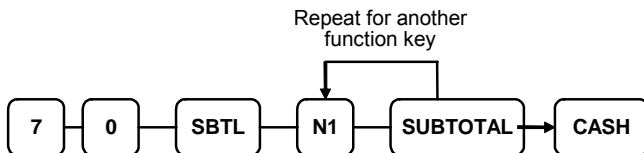

Address	OPTION	VALUE	=	SUM
N1	Key is inactive?	Yes = 1 No = 0		

### Descriptor

- Refer to "Program 80 – Function Key Descriptor"

## TABLE

### Options - Program 70

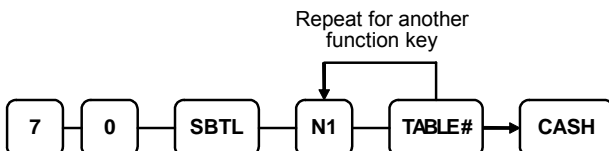

Address	OPTION	VALUE	=	SUM
N1	Table number entry compulsory before opening a new check?	Yes = 1 No = 0		
	Table number entry compulsory for all sales?	Yes = 2 No = 0		
	Print table# at the remote printer?	Yes = 4 No = 0		

### Descriptor

- Refer to "Program 80 – Function Key Descriptor"

# TARE

## Options - Program 70

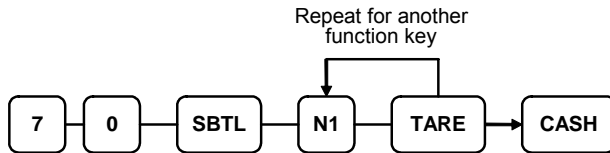

Address	OPTION	VALUE	=	SUM
N1	Key is inactive?	Yes = 1 No = 0		
	Key is active in X control lock position only?	Yes = 2 No = 0		
	Using tare number five to manually enter a tare weight?	Yes = 4 No = 0		

### Descriptor

- Refer to "Program 80 – Function Key Descriptor"

# TAX EXEMPT

## Options - Program 70

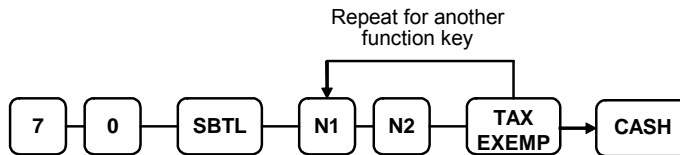

Address	OPTION	VALUE	=	SUM
N1	Exempt tax 1?	Yes = 1 No = 0		
	Exempt tax 2?	Yes = 2 No = 0		
	Exempt tax 3?	Yes = 4 No = 0		
N2	Exempt tax 4?	Yes = 1 No = 0		
	Compulsory non-add number before this key is used?	Yes = 2 No = 0		
	Validation is compulsory?	Yes = 4 No = 0		

### Descriptor

- Refer to "Program 80 – Function Key Descriptor"

# TIP

## Options - Program 70

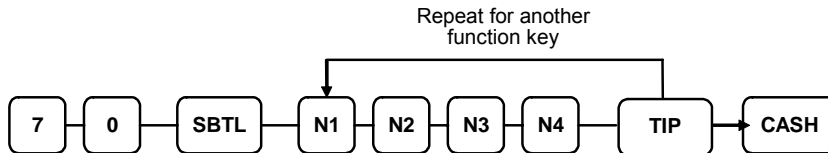

Address	OPTION	VALUE	=	SUM
N1	Type of tip is:	Percentage =	1	
		Amount =	0	
N2	Key is inactive?	Yes = 1 No = 0		
	Key is active in X control lock position only?	Yes = 2 No = 0		
	Add tax rate 1?	Yes = 4 No = 0		
N3	Add tax rate 2?	Yes = 1 No = 0		
	Add tax rate 3?	Yes = 2 No = 0		
	Add tax rate 4?	Yes = 4 No = 0		
N4	Add the tip total to the NET and GROSS sales total?	Yes = 1 No = 0		

### Descriptor

- Refer to "Program 80 – Function Key Descriptor"

# VALIDATE

## Options - Program 70

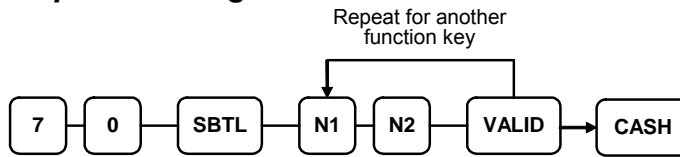

Address	OPTION	VALUE	=	SUM
N1	Enter Port Number.(0-2) Enter Zero if validation is not used.	0		
N2	Key is inactive?	Yes = 1 No = 0		
	Allow multiple validation?	Yes = 2 No = 0		

### Descriptor

- Refer to "Program 80 – Function Key Descriptor"

## VOID

### Options - Program 70

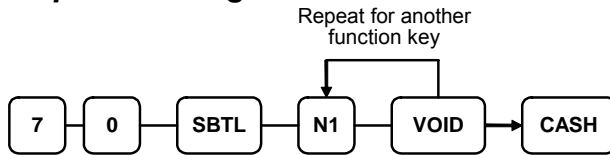

Address	OPTION	VALUE	=	SUM
N1	Key is inactive?	Yes = 1 No = 0		
	Key is active in X control lock position only?	Yes = 2 No = 0		
	Validation is compulsory?	Yes = 4 No = 0		

### Descriptor

- Refer to "Program 80 – Function Key Descriptor"

### HALO

- Refer to "Program 90 – Function Key HALO"

## WASTE

### Options - Program 70

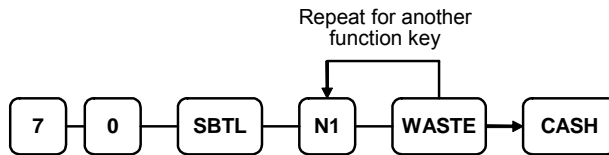

Address	OPTION	VALUE	=	SUM
N1	Key is inactive?	Yes = 1 No = 0		
	Key is active in <b>X</b> control lock position only?	Yes = 2 No = 0		
	Validation is compulsory?	Yes = 4 No = 0		

### Descriptor

- Refer to "Program 80 – Function Key Descriptor"

### HALO

- Refer to "Program 90 – Function Key HALO"

## %1- %5

### Options - Program 70

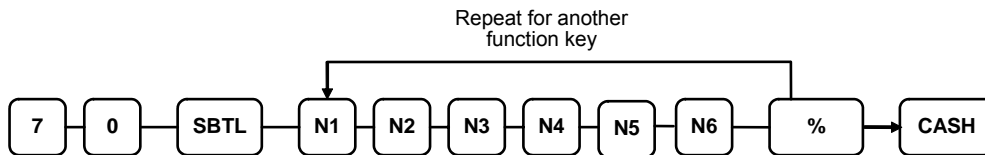

Address	OPTION	VALUE	=	SUM
<b>N1</b>	Apply an:	Amount =	1	
		<b>Percentage</b> =	<b>0</b>	
	Key is inactive?		Yes = 2 No = 0	
	% key is active in <b>X</b> control lock position only?		Yes = 4 No = 0	
<b>N2</b>	% key is:	Open =	1	
		<b>Preset</b> =	<b>0</b>	
	% key is:	Sale =	2	
		<b>Item</b> =	<b>0</b>	
Allow % key override preset?		Yes = 4 No = 0		
<b>N3</b>	% key is:	Positive =	1	
		<b>Negative</b> =	<b>0</b>	
	% amount taxable tax 1?		Yes = 2 No = 0	
<b>N4</b>	% amount taxable tax 2?		Yes = 1 No = 0	
	% amount taxable tax 3?		Yes = 2 No = 0	
	% amount taxable tax 4?		Yes = 4 No = 0	
<b>N5</b>	Reduce(or increase) the food stamp subtotal by % entry?		Yes = 1 No = 0	
	Allow only one time subtotal entry?		Yes = 2 No = 0	
	Allow multiple amount discounts (coupons) without pressing subtotal?		Yes = 4 No = 0	
<b>N6</b>	Allow % key preset override active in <b>X</b> control lock position only?		Yes = 1 No = 0	
	Validation is compulsory?		Yes = 2 No = 0	



## Descriptor

- Refer to "Program 80 – Function Key Descriptor"

## HALO - Program 90

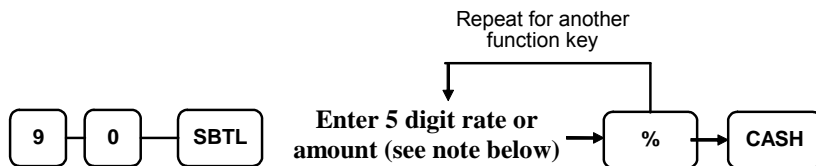

---

Note: If key is amount , enter 5 digit HALO, or 0 for no HALO. If key is percentage enter the percentage in a five digit format, without the decimal (XX.XXX). For example: for 10%, enter 10000; for 5.55%, enter 05550; for 99.999%, enter 9999 or 10000; for 5.55%, enter 05550; for 99.999%, enter 99999.

---

## KBD SHIFT

### Options - Program 70

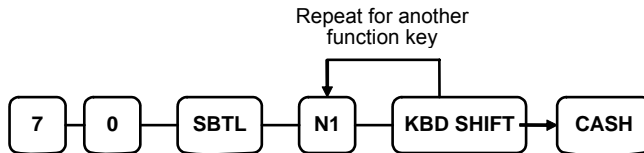

Address	OPTION		VALUE	=	SUM
N1	Key is inactive?	Pop up	0		
		Stay down	1		
	Key is active in <b>X</b> control lock position only?		Yes = 2 No = 0		

### Descriptor

- Refer to "Program 80 – Function Key Descriptor"

### HALO

90 ST number of NLU keys on Keyboard

This will enable the shift to move the PLU on the NLU by this number. I.e. If NLU has PLU#1 and you program 12 above, the KBD Shift will put PLU #13 on keyboard level 2, and PLU #25 on Shift 3.

---

## Clerk Programming

Clerks have the following programming options. These options are set through separate programs:

- *Program 800 - Secret Code programming* determines the code that is used for clerk sign on if a code entry sign on method is selected in system option #2 (See "System Option Programming")
- *Program 801 – Training Clerk Programming*. This allows the setting of a training clerk or alternative drawers.
- *Program 810 - Clerk Description Programming* allows you to set a unique, up to 18 character, descriptor for each clerk

## Program 800 – CLERK Secret Code Programming

1. Turn the control lock to the **P** position.
2. To begin the program, enter **8 0 0**, press the **SBTL** key.

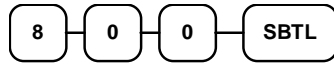

3. Enter the number (**1-15**) of the clerk you wish to program; press the **X/TIME** key.



4. Enter a secret code (up to 6 digits); press the **SBTL** key.

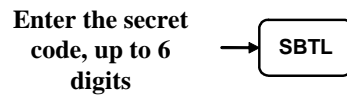

5. Repeat from step 3 for each clerk you wish to program. Press the **CASH** key to finalise the program.



## Program 801 - Clerk Status Programming

1. Turn the control lock to the **P** position.
2. To begin the program, enter **8 0 1**, press the **SBTL** key.



3. Enter the number (**1-15**) of the clerk you wish to program; press the **X/TIME** key.



4. Enter an option digit from the table below, press the **SBTL** key.

Address	OPTION	VALUE	=	SUM
<b>N1</b>	Drawer assignment (0: default drawer, 1: no drawer)	<b>1</b>		
<b>N2</b>	Training Clerk	Yes=1 No=0		



5. Repeat from step 3 for each clerk you wish to program. Press the **CASH** key to finalise the program.



## Program 810 - Clerk Description Programming

---

Program descriptors by typing descriptors on the alpha keyboard overlay or by entering three digit alpha character codes. To describe by three digit alpha character codes you must select 'No' in system option #25(See "System Option Programming").

---

1. Turn the control lock to the **P** position.
2. To begin the program, enter **8 1 0**, press the **SBTL** key.

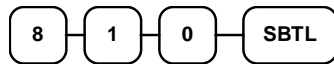

3. Enter the number (**1-15**) of the clerk you wish to program; press the **X/TIME** key.



4. If you are programming using alpha overlay;

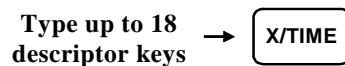

or,

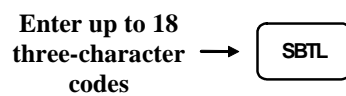

5. Press the **CASH** key to finalise the program.



---

## Mix & Match Programming

Mix & Match Tables have the following programming options. These options are set through separate programs:

- *Program 600 - Trip Level Programming*
- *Program 601 - Price Programming*
- *Program 610 - Mix & Match Description Programming* allows you to set a unique, up to 18 character, descriptor for Mix & Match Table.

## Program 600 - Trip Level Programming

1. Turn the control lock to the **P** position.
2. To begin the program, enter **6 0 0**, press the **SBTL** key.

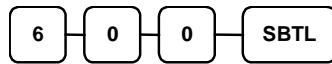

3. Enter the number of the M&M table you wish to program; press the **X/TIME** key.



4. Enter a level of up to 5 digits. (The Maximum Level you can enter is 30000) ; press the **SBTL** key.



5. Repeat from step 3 for each table you wish to program. Press the **CASH** key to finalise the program.



## Program 601 - Price Programming

1. Turn the control lock to the **P** position.
2. To begin the program, enter **6 0 1**, press the **SBTL** key.

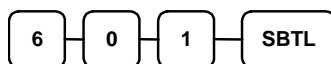

3. Enter the number of the M&M table you wish to program; press the **X/TIME** key.

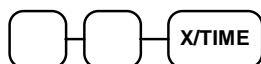

4. Enter a price (up to 7 digits); press the **SBTL** key.



5. Repeat from step 3 for each table you wish to program. Press the **CASH** key to finalise the program.



## Program 610 - Mix & Match Description Programming

---

Program descriptors by typing descriptors on the alpha keyboard overlay or by entering three digit alpha character codes. To describe by three digit alpha character codes you must select 'No' in system option #25(See "System Option Programming").

---

1. Turn the control lock to the **P** position.
2. To begin the program, enter **6 1 0**, press the **SBTL** key.

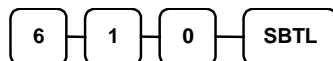

3. Enter the number of the M&M table you wish to program; press the **X/TIME** key.



4. If you are programming using alpha overlay;

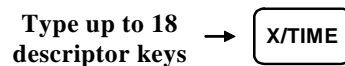

or,

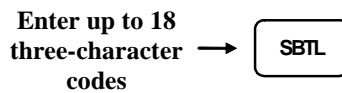

5. Press the **CASH** key to finalise the program.

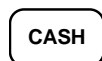

# Group Programming

Group totals are available to accumulate totals of individual PLUs that are assigned to each group. Each PLU can be assigned to one, two or three different groups.

- Use program 900 to assign a group status, i.e. a group can be set to *not add* to the total of all groups, or a group can be used to designate like items for kitchen printer assignment.
- Use program 910 to assign a unique descriptor for each group, so that the group may be easily understood on the group report.

## Programming Group Status - Program 900

1. Turn the control lock to the **P** position.
2. To begin the program, enter **9 0 0**, press the **SBTL** key.

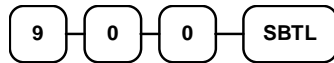

3. Enter the number of the group you wish to program; press the **X/TIME** key.



4. Enter an option digit from the table below, press the **SBTL** key.

Address	OPTION	VALUE	=	SUM
N1	Group total is added to the total of all group on the Group report?	Yes = 0 No = 1		
	Send to kitchen printer?	Yes = 2 No = 0		
N2	No Choice	0		
	KP PORT# : R(print a kitchen requisition)	1		
	KP PORT# : 1	2		
	KP PORT# : 2	4		
N3	Print RED on KP?	Yes = 1 No = 0		

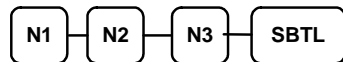

5. To program additional groups, repeat from step 3, or press the **CASH** key to finalise the program.



### **Programming Group Description**

1. Turn the control lock to the **P** position.
2. To begin the program, enter **9 1 0**, press the **SBTL** key.



3. Enter the number (**1-20**) of the group you wish to program; press the **X/TIME** key.



4. If you are programming using alpha overlay;

Type up to 18  
descriptor keys → 

or,

Enter up to 18  
three-character  
codes → 

5. To program additional groups, repeat from step 3, or press the **CASH** key to finalise the program.



---

# Miscellaneous Programming

## Macro Key Sequence Programming

Macros are special function keys that are used to execute a sequence of key depressions. For example, a macro might be used to execute a string of reports or to automatically tender a preset amount. Up to ten different macros may be placed on the keyboard. (See "Function Key Assignment Programming" to place macros on the keyboard.)

### To Program a Macro

1. Turn the control lock to the **P** position.
2. To begin the program, enter **1 5 0 0**, press the **SBTL** key.

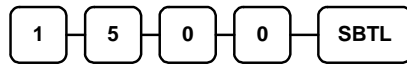

3. Press the **Macro** key that you wish to program.

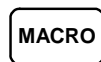

4. First, you must change the Mode Key. Default Mode is PGM Mode. Therefore, If you want to start in REG Mode, you must change Mode key to REG Mode. Type up to 50 key strokes

Type up to 50 key strokes

5. Turn the control lock to the P position. Press the same **Macro** key to end the sequence



6. Repeat from step 3 - 5 to program additional macros. Press the **CASH** key to finalise the program.



### To remove a Macro

If you wish to remove a key stroke from a macro, replace the current function with the INACTIVE function.

## Logo Description Programming

### ***Programming the Receipt/Check Endorsement Message***

A preamble message of up to six lines can be printed at the top of each receipt; a postamble message of up to six lines can be printed at the bottom of each receipt; an endorsement message of up to ten lines can be printed when a check is endorsed on an optional slip printer. Each line can consist of up to 24 characters.

1. Turn the control lock to the **P** position.
2. To begin the program, enter **7 0 0**, press the **SBTL** key.

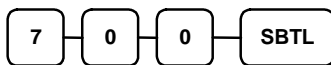

3. Refer to the chart below and enter the number that represents the line you wish to program; press the **X/TIME** key.

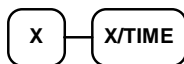

X	Message Line	X	Message Line
1	1 <sup>st</sup> line of Preamble	12	6 <sup>th</sup> line of Postamble
2	2 <sup>nd</sup> line of Preamble	13	1 <sup>st</sup> line of Endorsement
3	3 <sup>rd</sup> line of Preamble	14	2 <sup>nd</sup> line of Endorsement
4	4 <sup>th</sup> line of Preamble	15	3 <sup>rd</sup> line of Endorsement
5	5 <sup>th</sup> line of Preamble	16	4 <sup>th</sup> line of Endorsement
6	6 <sup>th</sup> line of Preamble	17	5 <sup>th</sup> line of Endorsement
7	1 <sup>st</sup> line of Postamble	18	6 <sup>th</sup> line of Endorsement
8	2 <sup>nd</sup> line of Postamble	19	7 <sup>th</sup> line of Endorsement
9	3 <sup>rd</sup> line of Postamble	20	8 <sup>th</sup> line of Endorsement
10	4 <sup>th</sup> line of Postamble	21	9 <sup>th</sup> line of Endorsement
11	5 <sup>th</sup> line of Postamble	22	10 <sup>th</sup> line of Endorsement

4. If you are programming

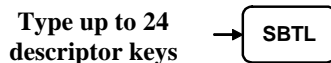

or,

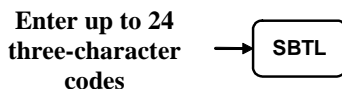

5. Press the **CASH** key to finalize the program.

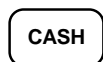

### ***Programming the Financial Report Message***

The Financial Report selection allows you to reprogram the descriptors that appear with the Financial Report totals and counters. For example, the first total on the financial report "+PLU TTL" represents the total of all positive PLU entries. You might wish to re-label this total to say "FOOD SALES". You can reprogram any of the Financial Report totals listed here with any 18-character descriptor. (See "Financial Report Message").

1. Turn the control lock to the **P** position.
2. To begin the program, enter **7 0 1**, press the **SBTL** key.

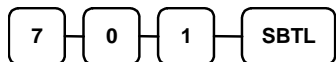

3. Refer to the chart below and enter the number that represents the line you wish to program; press the **X/TIME** key.

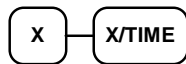

4. If you are programming using alpha overlay;

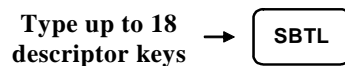

or,

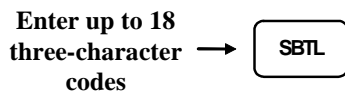

5. Press the **CASH** key to finalise the program.

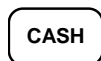

### **Programming the Clerk Report Message**

The Clerk Report selection allows you to reprogram the descriptors that appear with the Clerk Report totals and counters. For example, the first total on the clerk report "NET SALES" might be re-labeled to say "GROSS SALES". You can reprogram any of the Financial Report totals listed here with any 18-character descriptor. (See "Clerk Report Message").

1. Turn the control lock to the **P** position.
2. To begin the program, enter **7 1 0**, press the **SBTL** key.

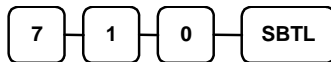

3. Refer to the chart below and enter the number that represents the line you wish to program; press the **X/TIME** key.

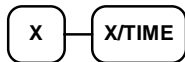

4. If you are programming using alpha overlay;

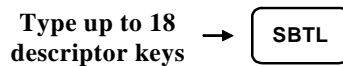

or,

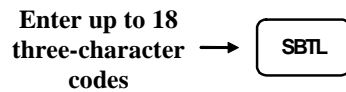

5. Press the **CASH** key to finalise the program.



### **Programming the Macro Name**

Up to ten function locations may be designated as Macro keys. You may wish to program a name for a macro. For example if a macro executes a series of commands to produce daily reports, you can program the descriptor "DAILY", so the macro can easily be identified. Macro names can also be helpful when looking at keyboard layout information with the PC communication utility.

1. Turn the control lock to the **P** position.
2. To begin the program, enter **7 1 1**, press the **SBTL** key.



3. Refer to the chart below and enter the number that represents the line you wish to program; press the **X/TIME** key.

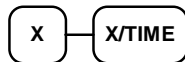

4. If you are programming using alpha overlay;

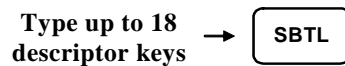

or,

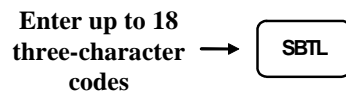

5. Press the **CASH** key to finalise the program.



### **Financial Report Message**

<b>X</b>	<b>Message Line</b>	<b>X</b>	<b>Message Line</b>	<b>X</b>	<b>Message Line</b>
1	+PLU TTL	32	ERROR CORR	63	CHG5 SALES
2	-PLU TTL	33	PREVIOUS VD	64	CHG6 SALES
3	ADJST TTL	34	VOID MODE	65	CHG7 SALES
4	NONTAX	35	CANCEL	66	CHG8 SALES
5	TAX1 SALES	36	GROSS SALES	67	FOREIGN 1
6	TAX2 SALES	37	CASH SALES	68	FOREIGN 2
7	TAX3 SALES	38	CHECK SALES	69	FOREIGN 3
8	TAX4 SALES	39	R/A 1	70	FOREIGN 4
9	TAX1	40	R/A 2	71	DRWR TTL
10	TAX2	41	R/A 3	72	PROMO
11	TAX3	42	P/O 1	73	WASTE
12	TAX4	43	P/O 2	74	TIP
13	XMPT1 SALES	44	P/O 3	75	TRAIN TTL
14	XMPT2 SALES	45	HASH TTL	76	BAL FORWARD
15	XMPT3 SALES	46	AUDACTION	77	GUESTS
16	XMPT4 SALES	47	NOSALE	78	P/BAL
17	EATIN TTL	48	CASH-IN-D	79	CHECKS PAID
18	TAKEOUT TTL	49	CHECK-IN-D	80	SERVICE
19	DRIVE THRU TTL	50	FD/S-IN-D	81	MIX&MATCH
20	% 1	51	CHG1-IN-D	82	ROUND TTL
21	% 2	52	CHG2-IN-D		
22	% 3	53	CHG3-IN-D		
23	% 4	54	CHG4-IN-D		
24	% 5	55	CHG5-IN-D		
25	NET SALE	56	CHG6-IN-D		
26	CREDIT TAX1	57	CHG7-IN-D		
27	CREDIT TAX2	58	CHG8-IN-D		
28	CREDIT TAX3	59	CHG1 SALES		
29	CREDIT TAX4	60	CHG2 SALES		
30	FD/S CREDIT	61	CHG3 SALES		
31	RETURN	62	CHG4 SALES		

**Clerk Report Message**

<b>X</b>	<b>Message Line</b>	<b>X</b>	<b>Message Line</b>	<b>X</b>	<b>Message Line</b>
1	NET SALE	25	CREDIT TAX3	49	CHG4 SALES
2	NONTAX	26	CREDIT TAX4	50	CHG5 SALES
3	TAX1 SALES	27	FD/S CREDIT	51	CHG6 SALES
4	TAX2 SALES	28	RETURN	52	CHG7 SALES
5	TAX3 SALES	29	ERROR CORR	53	CHG8 SALES
6	TAX4 SALES	30	PREVIOUS VD	54	FOREIGN 1
7	TAX1	31	VOID MODE	55	FOREIGN 2
8	TAX2	32	CANCEL	56	FOREIGN 3
9	TAX3	33	GROSS SALES	57	FOREIGN 4
10	TAX4	34	CASH SALES	58	DRWR TTL
11	XMPT1 SALES	35	SALES	59	PROMO
12	XMPT2 SALES	36	R/A 1	60	WASTE
13	XMPT3 SALES	37	R/A 2	61	TIP
14	XMPT4 SALES	38	R/A 3	62	TRAIN TTL
15	EAT IN TTL	39	P/O 1	63	BAL FORWARD
16	TAKEOUT TTL	40	P/O 2	64	GUESTS
17	DRIVE THRU TTL	41	P/O 3	65	P/BAL
18	% 1	42	HASH TTL	66	CHECKS PAID
19	% 2	43	CASH-IN-D	67	SERVICE
20	% 3	44	CHECK-IN-D	68	NOSALE
21	% 4	45	FD/S-IN-D	69	MIX&MATCH
22	% 5	46	CHG1 SALES		
23	CREDIT TAX1	47	CHG2 SALES		

## NLU Code Number Programming

NLU are fixed keys on the keyboard (like traditional department keys) that access specific PLUs. On the default keyboard, there are 12 NLU keys and the PLU# assigned to the NLU key is the same, i.e. NLU key number one is PLU #1. However, with this program, you can assign any PLU number you wish to any one of the 12 possible NLU keys.

### *Programming the NLU Code Number*

1. Turn the control lock to the **P** position.
2. To begin the program, enter **1 0 0 0**, press the **SBTL** key.

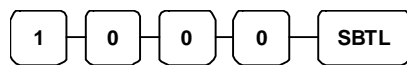

3. Type the new PLU code number you wish to use for this NLU key, and Press the NLU key on the keyboard you wish to program, and Press the NLU key again.

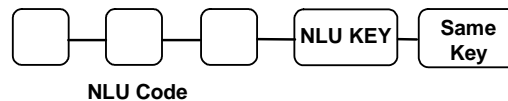

4. Press **CASH** to finalise the program

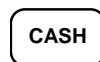

## Cash-In-Drawer Limit Programming

A Cash-In-Drawer limit can be programmed so that a warning appears on screen when the limit is exceeded. Pressing the **CLEAR** key will remove the error. The operator should carry out a Paid Out operation to reduce the Cash-in-drawer amount.

### *Programming the Drawer Limit*

1. Turn the control lock to the **P** position.
2. To begin the program, enter **1 1 0 0**, press the **SBTL** key.

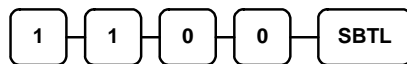

3. Enter a cash-in-drawer limit (up to 8 digits or **0** for no limit); press the **X/TIME** key.

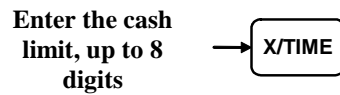

4. Press the **CASH** key to finalise the program.



## CHECK Change Limit Programming

Use this program to set the maximum amount of cash that can be returned when a CHECK is tendered for an amount greater than the amount of the sale. For example, if the CHECK change limit is \$10.00 the maximum amount that can be tendered into the CHECK key on a \$5.00 sale is \$15.00.

### *Programming the CHECK Change Limit*

1. Turn the control lock to the **P** position.
2. To begin the program, enter **1 2 0 0**, press the **SBTL** key.

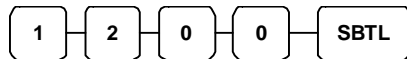

3. Enter a cash-in-drawer limit (up to 8 digits or **0** for no limit); press the **X/TIME** key.

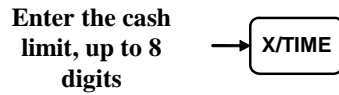

4. Press the **CASH** key to finalise the program.



## Date and Time Programming

Use this program to set the clock and calendar on your ER420M. The date changes automatically. After initial setting, time changing will probably be required only for beginning and ending daylight savings time.

### *Programming the Date and Time*

1. Turn the control lock to the **P** position.
2. To begin the program, enter **1 3 0 0**, press the **SBTL** key.

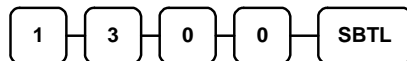

3. Enter time in military standard time (based on 24 hours), must be four digits (i.e. 1300 hours = 1:00 PM); press the **X/TIME** key.



4. Enter the date in MM(month) DD(day) and YY(year) format. Press the **X/TIME** key:



5. Press the **CASH** key to finalise the program.

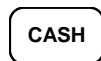

## Machine Number Programming

The machine number is printed on the register receipt. Program a machine number so that any receipt can be identified with the store or register where the transaction took place.

### *Programming the Machine Number*

1. Turn the control lock to the **P** position.
2. To begin the program, enter **1 6 0 0**, press the **SBTL** key.

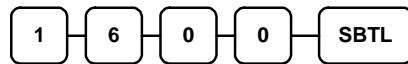

3. Enter a machine number (up to 5 digits); press the **X/TIME** key.



4. Press the **CASH** key to finalise the program.



---

## Program Scans

Since much time and energy has been invested in the planning and programming of your *ER-420M*, it is advisable to print a hard copy of the final program for future reference. This copy should be kept in a safe place.

1. Turn the control lock to the **P** position.
2. To print a program scan, enter **1 5**, press the **SBTL** key.



3. In this step, there are three different ways to scan program information. One is PLU, the other is Macro, The third is Others.

### PLU PROGRAM SCAN

To read one PLU program information, enter the number (1-1000) of the PLU and press the same number and **PLU** key.

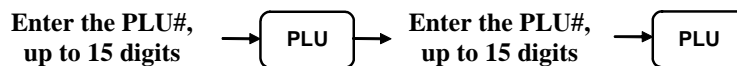

Press a PLU key on the keyboard and press same key again.



To read multiple PLU program information, enter the first number and press PLU key. Press the last number and press PLU key.

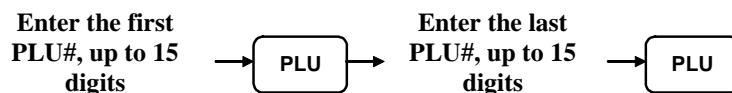

Press a PLU key on the keyboard .



### MACRO PROGRAM SCAN

To read MACRO information, press the MACRO key to be scanned,



Refer to the chart below and enter a digit to represent the segment of the program you wish to print; press the **X/TIME** key. To program additional scan, repeat this operation.



## OTHERS PROGRAM SCAN

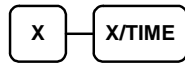

<b>X</b>	<b>Program</b>	<b>X</b>	<b>Program</b>
<b>0</b>	Group	<b>9</b>	Financial Report message
<b>1</b>	Tax	<b>10</b>	Clerk Report message
<b>2</b>	System option	<b>11</b>	Macro Name
<b>3</b>	Print option	<b>12</b>	Drawer Limit
<b>4</b>	Function keys	<b>13</b>	CHECK Change Limit
<b>5</b>	Clerk	<b>14</b>	Time & Date
<b>6</b>	Preamble message	<b>15</b>	Tare Weight
<b>7</b>	Postamble message	<b>16</b>	Machine Number
<b>8</b>	Endorsement message	<b>17</b>	Mix & Match

4. Press the **CASH** key to finalise the program.

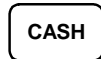

# Sample Reports

## Financial

	DATE 06/20/2003 WED	TIME 13:32
	X 1 REPORT	00001
	-----	
	FINANCIAL	
Total and count of all positive PLUs	+PLU TTL	179.56
Total and count of all Negative PLUs		\$288.60
Total of +PLU and -PLU sales	-PLU TTL	10
Total of Non-taxable sales		-20.00
Total of tax eligible sales for each sale tax	ADJST TTL	189.56
Total of tax collected for each tax		\$268.60
Total exempted sales for each tax	-----	
Total sales for each type of destination	NONTAX	\$30.47
Total and count for each % function key (i.e. discounts & coupons)	TAX1 SALES	\$153.60
	TAX2 SALES	\$11.92
	TAX3 SALES	\$16.77
	TAX4 SALES	\$31.89
	TAX1	\$10.00
	TAX2	\$1.21
	TAX3	\$1.18
	TAX4	\$2.18
	XMPT1 SALES	\$7.00
	XMPT2 SALES	\$1.50
	XMPT3 SALES	\$7.95
	XMPT4 SALES	\$7.50
	EATIN TTL	1
		\$10.12
	TAKEOUT TTL	2
		\$40.77
	DRTHRU TTL	1
		\$3.04
	% 1	3
		-0.48
	continued . . .	

continued from previous page

Total and count for each % function key (i.e. discounts & coupons)	% 2	2
		-5.22
	% 3	3
		\$3.23
	% 4	0
	\$0.00	
	% 5	0
		\$0.00
Net Sales	NET SALE	26
		\$281.18
Credited tax for each tax. (Tax is credited for negative taxable sales, i.e. mdse return transactions.)	CREDIT TAX1	4
		-1.11
	CREDIT TAX2	1
		-0.23
	CREDIT TAX3	2
	-0.89	
	CREDIT TAX4	1
		-0.39
Food stamp change credited to sales	FD/S CREDIT	0
		\$0.23
	RETURN	33
		-59.73
Total and count for each type of transaction correction.	ERROR CORR	2
		-4.00
	PREVIOUS VD	1
		-1.50
	VOID MODE	-2
		-6.40
	CANCEL	2
		\$16.00
Gross Sales	GROSS SALES	\$375.63
	CASH SALES	13
Totals and counters for CASH and CHECK sales		\$133.49
	CHECK SALES	1
		\$23.05
	R/A 1	1
		\$145.00
	R/A 2	0
		\$0.00
	R/A 3	0
		\$0.00
Total and count for each type R/A (received on account) and P/O (paid out) key.	P/O 1	1
		-140.00
	P/O 2	0
		\$0.00
	P/O 3	0
		\$0.00

continued . . .

Total and count of items sold with HASH status.

Count of No Sales.

Total of numbers entered into the non-add key

Total and count of expected CASH, CHECK in drawer

Total and count for each CHARGE in drawer.

Total and count for each CHARGE key.

Total for each Foreign currency in drawer.

continued from previous page

HASH TTL	0
	\$0.00
NOSALE	4
NON ADD #	547
CASH-IN-D	14
	\$269.99
CHECK-IN-D	3
	-108.45
FD/S-IN-D	2
	\$21.00
CHG1-IN-D	0
	\$0.00
CHG2-IN-D	1
	\$8.43
CHG3-IN-D	1
	\$8.52
CHG4-IN-D	2
	-1.60
CHG5-IN-D	1
	\$2.67
CHG6-IN-D	2
	\$13.09
CHG7-IN-D	0
	\$0.00
CHG8-IN-D	1
	\$0.00
CHG1 SALES	0
	\$0.00
CHG2 SALES	1
	\$8.43
CHG3 SALES	1
	\$8.52
CHG4 SALES	2
	-1.60
CHG5 SALES	1
	\$2.67
CHG6 SALES	2
	\$13.09
CHG7 SALES	0
	\$0.00
CHG8 SALES	1
	\$3.04
FOREIGN 1	0.00
FOREIGN 2	0.00
FOREIGN 3	0.00
FOREIGN 4	0.00

continued . . .

Total of CASH,  
CHECKS and  
CHARGES in  
drawer.

Total and count for  
PROMO,WASTE

Number of  
transactions and  
total activity in  
Training Mode

Average number of  
items per customer,  
and average dollar  
sales per customer

Grand total

continued from previous page

DRWR TTL	\$216.69
PROMO	1
	\$1.50
WASTE	8
	\$12.50
TRAIN TTL	5
	\$62.59
AVG ITEM/CUST	7.29
AVG \$/CUST	\$10.81
*****	
GRAND	\$375.63
ETHAN	No.000209 00000

# Time

Time Period

Number of Transactions

Net sales in this period.

Percentage of total sales

Number of Transactions all periods

Net sales in all periods.

DATE 06/20/2003 WED	TIME 15:48
X 1 REPORT	00001
-----	
TIME	
13:00-13:59	
CNT	17
SALES AMT	\$183.85
SALES RATE	65.39%
14:00-14:59	
CNT	9
SALES AMT	\$97.33
SALES RATE	34.61%
*****	
TOTAL CNT	26
TOTAL AMT	\$281.18
ETHAN	No.000236 00000

# PLU

PLU number

PLU Descriptor

Count and sales total.

Percentage of total sales (optional)

```

DATE 06/20/2003 WED    TIME 15:33
X 1  REPORT              00001
-----
ALL PLU
PLU#1
HAMBURGER
  CNT 28                  $42.00
  SALES RATE              15.64%
PLU#2
DBL BURGER
  CNT 40                  $99.75
  SALES RATE              37.14%
PLU#4
COKE
  CNT 26                  $38.85
  SALES RATE              14.46%
PLU#5
SPRITE
  CNT 18                  $13.42
  SALES RATE               5.00%
PLU#7
ROAST
  CNT 19.16               $30.47
  SALES RATE              11.34%
PLU#28
UNLEADED
  CNT 32.85               $39.39
  SALES RATE              14.66%
PLU#29
RETURNS
  CNT 10                  -20.00
  SALES RATE              -7.44%
PLU#33
NAILS
  CNT 15.55               $24.72
  SALES RATE               9.20%
*****
TOTAL CNT                  189.56
TOTAL AMT                 $268.60
ETHAN                      No.000213  00000
  
```

Total activity for all PLUs

Total sales for all PLUs.

# Clerk

Note: Media totals can be printed for each clerk, if selected in Print Option Programming.

Clerk Name

Number of Transactions

Net sales for this clerk

Drawer total for this clerk

DATE 06/20/2003 WED	TIME 15:36
X 1 REPORT	00001
-----	
ALL CLERK	
ETHAN	
NET SALE	10
	\$155.23
DRWR TTL	\$109.81
-----	
ZACH	
NET SALE	5
	\$45.14
DRWR TTL	\$43.22
-----	
ANNA	
NET SALE	4
	\$78.75
DRWR TTL	\$67.03
-----	
LAURA	
NET SALE	2
	\$0.00
DRWR TTL	\$18.64
-----	
PEGGY	
-----	
MOLLY	
NET SALE	5
	\$2.06
DRWR TTL	-22.01
-----	
ETHAN	No.000218 00000



---

## Individual Clerk

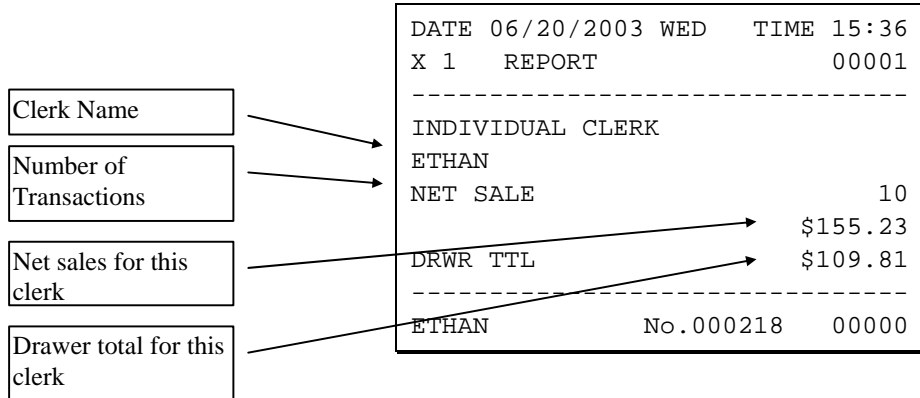

# Groups

Group Descriptor  
 Number of items sold in this group  
 Net sales for this group

```

DATE 06/20/2003 WED    TIME 15:34
X 1  REPORT              00001
-----
GROUP
GROUP : 1 FOOD
  CNT                      68
  SALES AMT                $141.75
GROUP : 2 DRINK
  CNT                      44
  SALES AMT                $52.27
GROUP : 3 REST.
  CNT                      112
  SALES AMT                $194.02
GROUP : 5 STORE
  CNT                      19.16
  SALES AMT                $30.47
GROUP : 8 MDSE
  CNT                      58.40
  SALES AMT                $44.11
GROUP : 9 STORE MDSE
  CNT                      77.56
  SALES AMT                $74.58
*****
TOTAL CNT                  189.56
TOTAL AMT                 $268.60
ETHAN                      No.000237  00000
  
```

Number of items sold in all groups.  
 Net sales for all groups.

# Stock

PLU number  
PLU Descriptor  
Current Stock count

```
DATE 11/10/1999 WED    TIME 15:47  
X 1  REPORT              00001  
-----  
ALL PLU STOCK  
PLU#1  
HAMBURGER  
  CNT                      26  
PLU#2  
DBL BURGER  
  CNT                      15  
PLU#7  
ROAST  
  CNT                      25.96  
PLU#28  
UNLEADED  
  CNT                    1488.47  
PLU#33  
NAILS  
  CNT                      161.25  
ETHAN                      000228  00000
```

---

## Open Check

Open check number  
and balance.

Clerk responsible  
for the check.

```
DATE 11/10/1999 WED    TIME 15:59
X 1  REPORT              00001
-----
OPEN CHECK
CHECK : 3                $24.07
MOLLY
CHECK : 4                $45.42
ETHAN
CHECK : 5                $24.50
ETHAN
CHECK : 6                $28.33
ETHAN

ETHAN                    000243    00000
```

JK65-00005A(Rev.01) ER-420M(GOD)